

# PRODUCT SPECIFICATION FOR INFORMATION

**Product Description: Transparent touch panel**

Designed by:付作韦

Date:2015-07-07

Checked by:邓福生

Date:2015-07-07

Approved by:汪陈

Date:2015-07-07

Customer Name:

Approved by:

**This was certainly received by us. One copy  
is being returned to you.**

Date Of Receipt:

**Shen Zhen Green Touch Technology Co.,Ltd**

TEL: 0755-29370883,29371519,23579950

FAX: 0755-29235565



# Table of contents

## 目录

- 1 **Sample Specification** 样品规格
  - 1.1 **Product name Code No.** 品名编号
  - 1.2 **Scope** 适用范围
  - 1.3 **Features and General Specifications** 特征和规格
  - 1.4 **Environment Conditions** 环境参数
  - 1.5 **Mechanical characteristics** 机械性能
  - 1.6 **Electric characteristics** 电器性能
  - 1.7 **Appearance** 外观
- 2 **Testing condition** 试验条件
  - 2.1 **Scope** 适用范围
  - 2.2 **Mechanical characteristics** 机械性能
    - 2.2-1 **Tapping durability** 敲击寿命
    - 2.2-2 **Pen sliding durability** 笔画寿命
    - 2.2-3 **Operation force** 操作压力
    - 2.2-4 **Impact resistance** 耐冲击试验
    - 2.2-5 **Static load resistance** 耐静压性测试
    - 2.2-6 **Flexible pattern heat seal peeling strength** 引线拉力测试
    - 2.2-7 **Flexible pattern bending resistance** 引线耐弯曲性测试
    - 2.2-8 **Vibration resistances (product)** 耐振动性测试 (产品)
    - 2.2-9 **Package drop** 包装跌落测试
    - 2.2-10 **Flexible pattern heat resistance to soldering** 引线焊接耐热测试
  - 2.3 **Electric characteristics** 电器性能
    - 2.3-1 **Terminal resistance** 回路电阻
    - 2.3-2 **Insulation resistance** 绝缘阻抗测试
    - 2.3-3 **Linearity** 线性测试
  - 2.4 **Appearance limit standard** 外观检验标准
    - 2.4-1 **Scope** 适用范围
    - 2.4-2 **Dot –like foreign matter** 点状杂物
    - 2.4-3 **Linear foreign matter** 线状杂物
    - 2.4-4 **Chip and crack** 碎裂、破损
    - 2.4-5 **Scratch** 刮伤
    - 2.4-6 **Fish eye on film, Dent on film and Air bubble** film 上的鱼眼、凹痕、气泡
    - 2.4-7 **Newton’s ring** 牛顿环
    - 2.4-8 **Air-bubble of OCA inspection standard (assemble overlay with OCA)**  
OCA 的气泡检验标准(用透明胶组合面版)
    - 2.4-9 **Other** 其它
- 3 **Reliant condition** 信赖性条件
  - 3.1 **Temperature condition** 环境条件
    - 3.1-1 **Temperature and Humidity resistance Test** 耐高温高湿测试
    - 3.1-2 **Heat resistance** 耐热性
    - 3.1-3 **Cold resistance** 耐寒性
    - 3.1-4 **Thermal shock** 冷热冲击
- 4 **Precautions in use** 使用过程中的注意事项
  - 4.1 **Cautions for storage** 储存的注意事项

- 4.2 Cautions for unpacking 卸货的注意事项
- 4.3 Cautions for handling 搬运的注意事项
- 4.4 Cautions for installing and assembling 组合上机的注意事项
- 4.5 Cautions for operation 操作过程中的注意事项
- 4.6 Other cautions 其它注意事项
- 5 Handling of product specification for information 样品承认书的反馈
- 6 Attachment 附件
  - 6.1 Engineering Drawing 工程图

## Warranty

Products manufactured to these specifications shall be capable of meeting all characteristics from GREEN TOUCH'S delivery onwards or for a minimum period of 6 month of the customer received when stored and used as specified under normal conditions within the contents of these sheets.

保证

此规格触摸屏，从格林兴出货之日起或客户收到产品后，至少 6 个月内应符合下列正常条件下的储存和使用规格。

## 1 Sample Specification 样品规格

### 1.1 Product name Code No.: Transparent touch panel

品名编号：透明触摸屏

### 1.2 Scope

适用范围

This specification shall apply to analog type pen or finger input transparent touch panel.

此样品为类比式透明触摸屏。

### 1.3 Features and General Specifications

特征和规格

#### ● Features 特征

Construction 结构	Materials used 所用材料	Code No. 编号	Comment 注释
Top Circuit 上线	PET 薄膜	KS	Mist hard coating & anti-Newton rings ITO Film ; Thickness: 0.188mm 雾面防刮防牛顿环导电薄膜，厚度 0.188mm
Circuit spacer 线键	Double-sided adhesive 双面胶	9312	Thickness:0.12mm 厚度： 0.12mm
Bottom Circuit 下线	Glass 玻璃	41607140 7	ITO Glass ; Thickness: 1.8mm 导电玻璃，厚度： 1.8mm
Tail type 引线	FPC	103254	Connector thickness: 3.0mm 端子厚度: 3.0mm

● General Specifications 规格 (L=long 长; W=wide 宽; T= thickness 厚)

Item 项目	Specifications 规格	Unit 单位
Dimensional Outline 外形尺寸	322.00 (L) × 247.00 (W) × 2.3(T)	mm
Viewing Area 可视区	310.50 (L) × 236.00 (W)	mm
Active Area 驱动区	304.00 (L) × 228.00 (W)	mm
Spacer dots: dimension & pitch 绝缘点大小及点距	φ 0.08+0.02 -0, 4×4	mm

1.4 Environment Conditions 环境参数

Items 项目	Value 值
Operating temperature & Humidity 工作温湿度范围	-20°C-+70°C: -20°C-+40°C, <90%RH +40°C-+70°C, <60%RH
Storage temperature & Humidity 储存温湿度范围	-30°C-+80°C: -30°C-+40°C, <90%RH +40°C-+60°C, <60%RH +60°C-+80°C, <50%RH <64H

1.5 Mechanical characteristics 机械性能

Items 项目	Value 值			
Operation force 操作压力	60-150g			
Operation life 操作寿命	Tapping durability 敲击寿命	1,000,000 times min. >1,000,000 次		
	Pen sliding durability 笔画寿命	100,000 times min. >100,000 次		
Optical characteristics 光学特性	Transparency 透明度 >75%	Haze 雾化度 <12%	Clarity 清晰度 >83%	Gloss 光泽度 >170GU
Hardness 表面硬度	>3H			
Capacitance 电容值	<5nF			

1.6 Electric characteristics 电器性能

Items 项目	Value 值	
Max voltage 最大电压值	5V (DC) 5V (直流)	
Max current 最大电流值	Top layer 上线路	35mA
	Bottom layer 下线路	35mA
Terminal resistance 回路电阻	GLASS: 50 Ω -250 Ω	
Insulation resistance 绝缘阻抗	10MΩ or over (DC25V) >10MΩ (直流25V)	
Linearity 线性	Less than 1.5% <1.5%	
Chattering Time 触点抖动时间	Less than 15ms <15ms	

## 1.7 Appearance

外观

- **Shape and dimensions:** As specified in individual drawings.  
形状和尺寸：按图档说明
- **Structure, and Area definition:** The structure and the performance guaranteed areas of this touch panel are defined below.

构造和区域定义：T/P结构与外观确保如下：

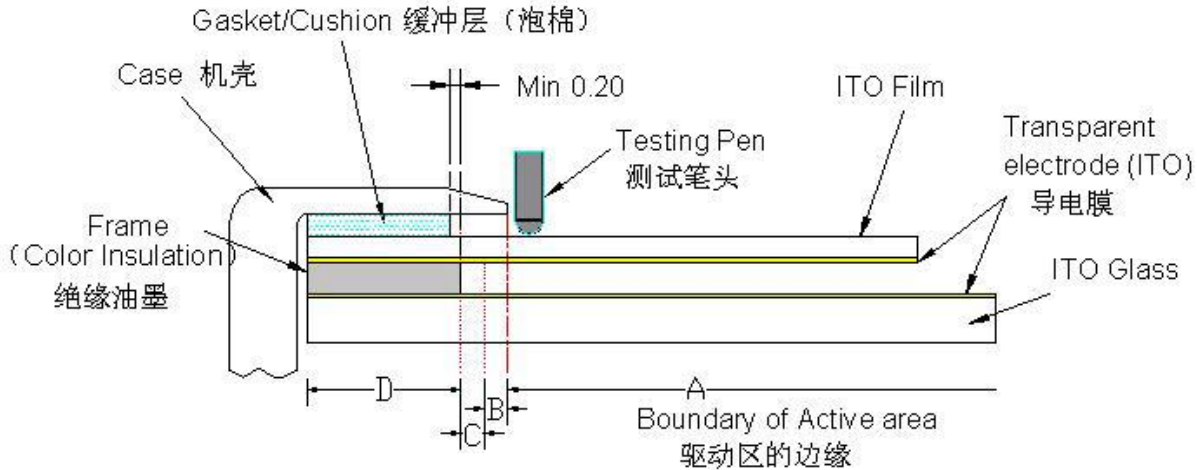

### Area-(A) : Active area

区域(A)： 驱动区

The area guarantees a touch panel operation with the following characteristics when pressed.

在按压 T/P 的驱动区时能够保证以下特性操作正常：

- ( i ) Operation force 操作压力
- ( ii ) Electric characteristics 电器性能
- ( iii ) Tapping durability 敲击寿命
- ( iv ) Pen sliding durability 笔画寿命

### Area-(B) : Operation non-guaranteed area

区域(B)： 非保证操作区

The area does not guarantee a touch panel operation and its function. When this area is pressed, touch panel shows degradation of its performance and durability such as a pen sliding durability becomes about one-tenth compared with the active area (Area- (A) as guaranteed area) and its operation force requires about double. About 0.5 mm outside from a boundary of the active area corresponds to this area.

此区域不保证T/P操作和功能正常。当按压此区域时，T/P的外观和寿命将会下降。如：当对它做笔画测试时，笔画寿命大约为驱动区寿命的1/10（如图中驱动区A），并且操作压力也要求是驱动区的两倍。此区域位置大约为驱动区外侧0.5mm。

### Area-(C) : Pressing prohibition area

区域(C)： 禁止按压区

The area forbids pressing because an excessive load is applied to a transparent electrode and a serious damage is given to a touch panel function by pressing. About 0.5mm outside from a boundary of Area-(B)” the operation non-guaranteed area” corresponds to this area.

此区域为禁止按压的原因是施加重压会造成透明电极破坏，并且 T/P 的功能严重损坏。此区域位置大约为区域(B)即“非保证操作区”外侧 0.5mm。

### **Area-(D) : Non-Active area (Frame)**

区域(D): 非驱动区

The area does not activate even if pressed.

此处按压不动作。

(Remark: In order to prevent unusual performance degradation and malfunction of a touch panel, please inspect firstly whether the set case designing and touch panel assembling method are reasonable or not, and then start to install and assemble after surely confirming the item "4.4 Cautions for installing and assembling".)

(备注: 为了避免产品外观不良和产品出现故障, 请预先检查实施的机壳的设计方案和T/P的上机组合方式是否合理, 并且了解项目“4.4 组合上机的注意事项”后再上机。)

### **Area-(B)+Area-(C): Sensitive area**

区域(B)+区域(C): 敏感区

Area-(B) and area-(C) both belong to the sensitive area. This area has a clearance between top and bottom contact side. Great press resulting in transparent electrode cracks, function defect to be exact, will deform surface transparent electrode. Please think about structure of sensitive area and case in order to avoid terminal user to fail to touch this area.

区域(B)、(C)为敏感区, 由于该区域在产品上下导电面之间存在间隙, 按压此处时ITO导电膜受压产生较大变形, 引起ITO导电膜断裂, 从而使触摸屏丧失功能。故使用触摸屏产品时, 一定要充分考虑敏感区的尺寸及外壳的构造, 必须避免最终的用户使用时触及到此区域。

Remark: Please add a layer of gasket/ cushion around it before assembling touch panel. Take care that gasket/ cushion's location should be in the limits of Frame area's location. Min. 0.2mm outside from an inner boundary of Frame area corresponds to this area:

- ① If designed case's size is bigger than active area's size, terminal user could touch sensitive area to damage touch panel;
- ② If designed case's size is smaller than active area's size, ITO transparent electrode will not damage when sliding test on the edge of case as sensitive area is covered by case around. But cushion/gasket's thickness looks so important when case enters into active area: If too thick, the clearance of case and surface transparent electrode will be so big as to affect touch panel's appearance. If too thin, the case will be pressed directly on the touch panel's surface, which have to be damaged resulting in short circuit. Therefore, you'd better keep clearance of 0.2-0.3 mm between case and transparent electrode.

备注: 组装触摸屏时, 必须在产品表面四周加上一层缓冲层/泡棉, 再装外壳。缓冲层/泡棉应落在绝缘油墨上, 且最好在绝缘油墨上外扩至少0.2mm:

- ①若外壳设计比驱动区大时, 最终用户有可能触及到敏感区而损伤产品;
- ②若外壳设计为比驱动区小时, 由于外壳四周完全遮盖了敏感区, 因此当沿屏边缘划动时, 不会造成ITO层的损伤, 但是因为外壳伸进了动作区, 因此防垫圈的厚度就显得很重要, 太厚, 外壳与膜表面之间的间隙太大, 影响产品的外观, 太薄, 外壳直接压在膜表面上, 会造成短路, 最好外壳与膜表面之间保持在0.2~0.3mm之间。

## 2 Testing Condition 试验条件

### 2.1 Scope

适用范围

The standard conditions are 23 °C ,65 %RH and 1013hPa, and measurement shall be done at normal temperature(5 °C to35 °C ) and humidity(45%RH to 85%RH) and normal atmospheric pressure(860hPa to1060hPa) .In the case of accuracy and reappearance necessity, measurement shall be done at 23 °C ±5 °C ,65 %RH±10 %RH and 860 h Pa to 1060hPa after exposing in these conditions for 24 h.

标准环境为：23°C,65%RH 和 1013hPa，应在常温条件（5°C- 35°C），湿度为 45%-85%RH，和气压为 860hPa-1060hPa 下进行测试。倘若有必要对产品进行再测试，并且为使产品测试准确，可在 24 小时放置之后，在 23°C ± 5°C，65%RH ± 10%RH 和 860hPa-1060hPa 下进行测试。

### 2.2 Mechanical characteristics

机械特性

#### 2.2-1 Tapping durability 敲击寿命：

- 1) Matrix & 4-wire resistive type : Tapping more than 1million times with 250g force and 2times/s frequency by  $\phi$  2 Polyacetal pen, whose hardness is HRR60~80 .The requirements in item “1.6 Electric characteristics” shall be satisfied.

矩阵式、四线电阻式：使用  $\phi$  2、HRR60~80 的聚纤维酯笔，250g 的力度、频率 2 次/秒来回敲击 100 万次后，满足“1.6 电器性能”项目要求。

- 2) 5-wire resistive type : Sliding more than 35 million times with 250g force and 2times/s frequency by  $\phi$  2 Polyacetal pen and whose hardness is HRR60~80 .The requirements in item “1.6 Electric characteristics” shall be satisfied.

五线电阻式：使用  $\phi$  2、HRR60~80 的聚纤维酯笔，250g 的力度、频率 2 次/秒来回敲击 3500 万次后，满足“1.6 电器性能”项目要求。

#### 2.2-2 Pen sliding durability 笔画寿命

(Remark: The sliding place should be more than 3mm inside from the boundary of active area.)

(备注：画线的位置应位于 AA 区以内，距离 AA 区边缘 > 3mm.)

- 1) 4-wire resistive type : Sliding more than 100 thousand times with 250g force and 60mm/s frequency in the same position(10-100mm) by  $\phi$  2 Polyacetal pen .The requirements in item “1.6 Electric characteristics” shall be satisfied.

四线电阻式：使用  $\phi$  2 聚纤维酯笔、250g 的力度、以频率为 60mm/s 在相同的位置（10-100mm）来回笔画 10 万次后，满足“1.6 电器性能”项目要求。

- 2) 5-wire resistive type : Sliding more than 1million times with 250g force and 60mm/s frequency in the same place (10-100mm) by  $\phi$  2 Polyacetal pen .The requirements in item “1.6 Electric characteristics” shall be satisfied.

五线电阻式：使用  $\phi$  2 聚纤维酯笔、250g 的力度、以频率为 60mm/s 在相同的位置（10-100mm）来回笔画 100 万次后，满足“1.6 电器性能”项目要求。

#### 2.2-3 Operation force: 60-150g(Tip $\phi$ 2mm Polyacetal pen operation.)

操作压力: 60-150g (用  $\phi$  2 的聚纤维酯笔操作)

(Remark: Depending on the pitch & the dimension of the spacer dots in between.)

(备注：由绝缘点的间距及大小来决定操作压力的大小.)



## 2.2-4 Impact resistance:

耐冲击试验

- Testing condition

测试条件

No glass break when 64g,  $\phi$  25.4mm steel ball is dropped vertically on the center of film surface from 12-80cm height at 1 time according to 0.7-3.0mm thinness glass. Sample to be tested is only Film+Glass type.

(Remark: Testing height would be increased by per10cm height for making the steel ball dropping vertically in our company, and then record the Min Breakage Height.)

当用 64g,  $\phi$  25.4mm 钢球从 12-80cm 的高度垂直跌落在玻璃厚度为 0.7-3.0mm 的产品表面中心一次, 玻璃不会损坏。此试验只适用于 Film+Glass 类型的产品。

(备注: 我司是以每隔10cm为一个测试高度, 逐步增加让钢球自由落下, 记录钢球击碎T/P时之高度。)

- Judgment

判定基准

Under the fixed condition or in view of customer's requirement, sample characters would be satisfied basically without obvious change and up-and-down rate is less than 20% compared with untested sample.

在规定的条件下或客户指定的条件下, 产品各项特性基本满足, 比较未有明显变化并且变动率小于 20%。

## 2.2-5 Static load resistance

耐静压性测试

- Testing condition

测试条件

No glass break or crack after pressing the product vertically on the center of film surface with 8-20  $\text{kg}/\text{cm}^2$  by 15mm dia. testing pen of the manometer according to 0.7-3.0mm thinness glass. Sample to be tested is only Film+ Glass type.

(Remark: In view of different glass thickness, the surface of T/P would be increased by even load in our company and then record the Min Breakage Height.)

使用拉压力计的平头测试头(直径为15mm)对玻璃厚度为 0.7-3.0mm 的产品表面中心垂直施加 8-20 $\text{kg}/\text{cm}^2$  压力, 确保玻璃不毁坏破裂。此试验只适用于Film+Glass类型的产品。

(备注: 我司是针对不同厚度的玻璃, 以均匀的压力逐步加压力于T/P的表面, 观察记录T/P破裂高度。)

- Judgment

判定基准

Under the fixed condition or in view of customer's requirement, sample characters would be satisfied basically.

在规定的条件下或客户指定的条件下, 产品各项特性基本满足, 无明显变化。

## 2.2-6 Flexible pattern heat seal peeling strength:

引线拉力测试:

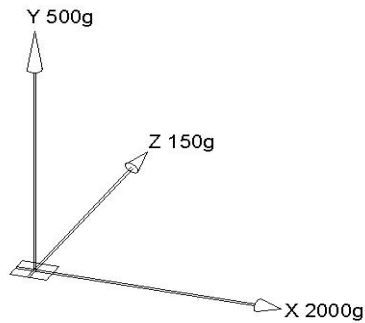

X: 2000g (peeling by 180°) X方向: 2000g (水平方向180度剥离)

Y: 500g (peeling upward by 90°) Y 方向: 500g (朝上方向90度剥离)

Z: 150g (peeling for being vertical with x and y direction) Z 方向: 150g (铅垂方向剥离)

### 2.2-7 Flexible pattern bending resistance

引线耐弯曲性测试:

Bending 3 times or more by bending radius R1mm. The requirements in “Terminal resistance” of the item “1.6 Electric characteristics” shall be satisfied.

弯曲半径为1mm弯曲次数为3次或3次以上，满足“1.6 电器性能”里的“回路电阻”项目要求。

### 2.2-8 Vibration resistances:

耐振动性测试

- 1) In operation: The requirements in “insulation resistance” of the item “1.6 Electric Characteristics” shall be satisfied, when sweep vibration of 2 m/s<sup>2</sup>, 10 Hz to 55 Hz (1 min.) is given for 30 min. each in the directions of X, Y, Z.

操作时: 当在 X, Y, Z 各方向以 2m/s<sup>2</sup> 的加速度, 10Hz-55Hz (1 分钟) 频率振动, 持续 30 分钟, 满足“1.6 电器性能”里的“绝缘阻抗”项目要求。

- 2) Not in operation: The requirements in “Operation force” of the item “1.5 Mechanical characteristics” and “1.6 Electric characteristics” shall be satisfied after sweep vibration of 20 m/s<sup>2</sup>, 10 Hz to 55 Hz (1 min) is given for 30 min. each in the directions of X, Y, Z.

非操作时: 当在 X, Y, Z 各方向以 20m/s<sup>2</sup> 的加速度, 10Hz-55Hz(1 分钟) 频率振动, 持续 30 分钟, 满足“1.5 机械性能”里的“操作压力”和“1.6 电器性能”项目要求。

### 2.2-9 Package drop

包装跌落测试:

No damage to the product when the biggest side of package drops about 2 times from 80cm height (each in upper and bottom surface).

(Remark: This item is only common testing. Should our customer have special requirement, we could test according to different product.)

包装盒面积最大面从 80cm 高度跌落两次 (正反面各一次), 产品不破损。

(备注: 此项目仅为一般测试, 若客户有特殊要求, 我们将针对不同厚度的产品进行测试。)

### 2.2-10 Flexible pattern heat resistance to soldering

引线焊接耐热测试:

Manual soldering temperature shall be less than temperature 320 °C for 3s. Only one soldering is allowed again. Soldering iron with 60 W Max(Tip diameter: φ 1 mm Max.). The requirements in “Operation force”、 “Light transparency” of the item “1.5 Mechanical characteristics” and “1.6 Electric characteristics” shall be satisfied.

手工焊接温度应小于 320 摄氏度, 持续 3 秒。而重复焊接只能一次。烙铁应在小于 60W 的环境下 (直径最大 1mm), 满足“1.5 机械性能”里的“1.6 电器性能”项目要求。

## 2.3 Electric characteristics 电器性能

### 2.3-1 Terminal resistance 回路电阻

1) Matrix type: Please press on the both ends of tail by multimeter's testing pen (5V) for the max terminal resistance. Make sure that terminal resistance would be identical with the item "Terminal resistance" in "1.6 Electric characteristics".

(Remark: The tested tail should be a group of the longest and the thinnest loop circuit among them.)

矩阵式：用万用表(5V)的测试头按压于引线末端，测试产品的最大回路电阻，确保回路电阻满足“1.6 电器性能”中的“回路电阻”项目要求。

(注：测试引线应是上下电极间一组最长最细的回路)

2) Analog type: Please press on the end of tail by multimeter's testing pen (5v). Testing the terminal resistance of each layer. Make sure that the testing value would be identical with the item "1.6 Electric characteristics".

类比式：用万用表(5V)的测试头按压于引线末端，测试产品每层电极的回路电阻。确保测试结果满足“1.6 电器性能”项目要求。

### 2.3-2 Insulation resistance 绝缘阻抗测试

Method one 方法一

Use the high voltage machine. Initialize voltage value and the max. resistance "10 MΩ" in advance, and then make testing jig press on the end of tail. Make sure that the value would be more than 10 MΩ. (The screen will appear "pass".)

使用高压测试机进行测试。首先预设电压值和最大电阻值为 10 MΩ，然后用测试夹具压于引线末端，确保测试绝缘阻抗大于 10 MΩ。(屏幕将显示 "pass" 字样)

Method two 方法二

Please press on the end of tail by insulating meter's testing pen (25v). Testing the insulation resistance of the product. Make sure that the insulation resistance would be more than 10 MΩ.

用绝缘表(25V)的测试头按压于引线末端，测试产品的绝缘阻抗。确保绝缘阻抗大于 10 MΩ。

### 2.3-3 Linearity (This is only according to analog type.)

线性测试 (只是针对类比式产品而言)

Use linearity testing machine. Be sure that the result would less than 1.5%.

用线性测试机进行测试确保读数小于 1.5%。

## 2.4 Appearance limit standard

外观检验标准

### 2.4-1 Scope

适用范围

This standard is only according to the view area (inside of frame). For the outside of view area, it would not be regarded as a defect that there is no possibility of causing influences to the performance for example: affixture, stain and so on which are able to be wiped away and washed on the surface of product. However, the item "Chip and Crack" applies to the whole part of the product.

这个标准只是针对可视区而言，因为可视区以外的区域对 T/P 的外观不会产生任何影响。如：T/P 表面有可擦拭的粘附物、污渍等等将不作外观不良处理。但产品项目“碎裂、破损”是针对整个产品而言。

<Inspection condition> <检测条件>

Source of the lighting for inspection is 12-20 W cool white color of fluorescent light for 400-500mm long between product and a source of light. Viewing distance for inspection between eyes and product is kept 18-20". Meanwhile, add a black cardboard under the product as background. Inspection time is less than 10 sec for each piece as the following.

在距离产品 400-500mm 的 12-20W 的冷白色荧光灯下检测，目测距离为 300-400mm，并且在产品的下方加以黑色的纸板作为衬托背景，每片产品检测时间不超过 10 秒，如图：

A source of light (12-20W)

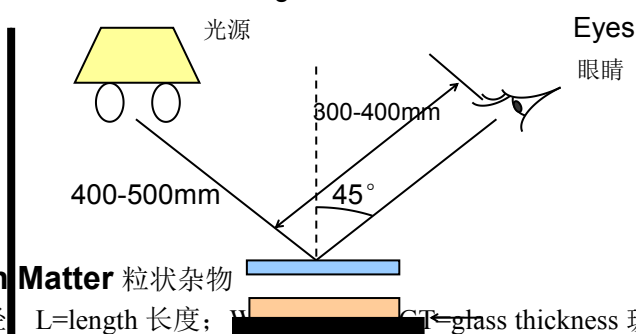

### 2.4-2 Dot-like Foreign Matter 粒状杂物

(Remark: D=diameter 直径; L=length 长度; W=width 宽度; GT=glass thickness 玻璃总厚)

CRITERIA	DECISION
D<0.2mm 直径<0.2mm	Ignored 可忽略
0.2mm≤D≤0.3mm 0.2mm≤直径≤0.3mm	The object that is>25mm in distance from any other foreign object is ignored. 粒状杂物与另一杂物之间的距离>25mm, 可以忽略; The object is <25mm in distance from any other foreign object. Two objects are allowed. 粒状杂物与另一杂物之间的距离<25mm,只允许有两个存在;
D>0.3mm 直径>0.3mm	The T/P is regarded as a defect. T/P 属不良品。

### 2.4-3 Linear Foreign Matter 线状杂物

CRITERIA	DECISION
W<0.025mm 宽<0.025mm	Ignored. 可以忽略
0.025mm≤W≤0.035mm 0.025mm≤宽≤0.035mm	L≤4mm, the object is >20mm in distance from any other foreign object is ignored. 长≤4mm, 与另一杂物之间的距离>20mm, 可以忽略; L≤4mm, the object is <20mm in distance from any other foreign object. Two objects are allowed. 长≤4mm, 与另一杂物之间的距离<20mm, 只允许有两个存在;
0.035mm<W<0.05mm 0.035mm<宽<0.05mm	L<2.5mm, two objects are allowed. 如果 L<2.5mm,允许有两个存在;
W<0.05mm and L<5mm 宽<0.05mm 且长<5mm	One white line or fiber that is on the edge of T/P is allowed. 允许有一条白线或纤维的存在且白线或纤维只能在 T/P 的边缘。

## 2.4-4 Chip And Crack 玻璃断裂

**Corner fragment:**  $X \leq 3.0\text{mm}$  and  $Y \leq 3.0\text{mm}$  and  $Z \leq \text{GT}$  it is ignored

- 1) Corner fragment in the golden finger that seriously affects the product function is regarded as a defect.
- 2) Corner fragment in the circuit that seriously affects product function is regarded as a defect.

角断裂:  $X \leq 3.0\text{mm}$ ,  $Y \leq 3.0\text{mm}$  和  $Z \leq \text{GT}$ , 可以忽略

- 1) 若角断裂位于金手指处, 严重影响产品的功能, T/P 属不良品;
- 2) 若角断裂位于线路上, 严重影响产品的功能, T/P 属不良品。

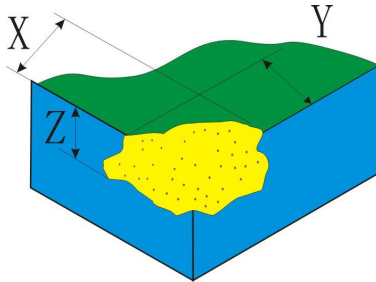

**Side fragment:**  $X \leq 6.0\text{mm}$  and  $Y \leq 2.0\text{mm}$  and  $Z \leq \text{GT}$  it is ignored

- 1) Side fragment in the golden finger that seriously affects the product function is regarded as a defect.
- 2) Side fragment in the circuit that seriously affects product function is regarded as a defect.

边断裂:  $X \leq 6.0\text{mm}$ ,  $Y \leq 2.0\text{mm}$  和  $Z \leq \text{GT}$ , 可以忽略。

- 1) 若边断裂位于金手指处, 严重影响产品的功能, T/P 属不良品;
- 2) 若边断裂位于线路上, 严重影响产品的功能, T/P 属不良品。

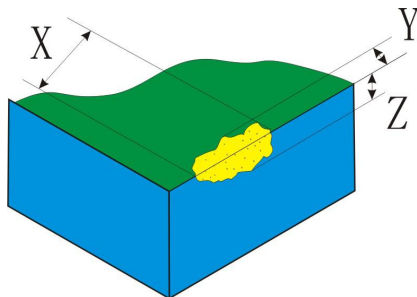

**Progressive:** T/P is regarded as defect.

裂纹: T/P 属不良品。

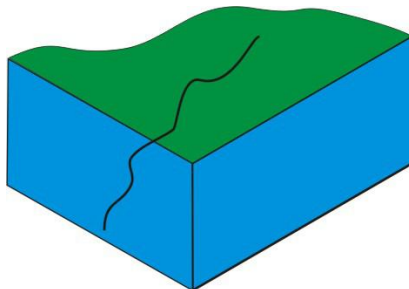

### 2.4-5 Scratch 刮痕

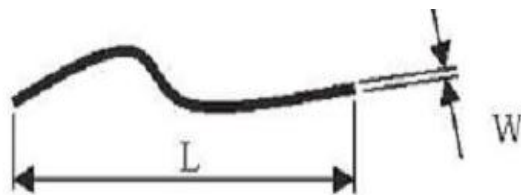

CRITERIA	DECISION
$W < 0.03\text{mm}$ 宽 $< 0.03\text{mm}$	$L \leq 15\text{mm}$ the scratch is ignored 长 $\leq 15\text{mm}$ 的刮伤可以忽略
$0.03\text{mm} \leq W \leq 0.05\text{mm}$ $0.03\text{mm} \leq \text{宽} \leq 0.05\text{mm}$	$L \leq 20\text{mm}$ , the scratch that is $> 40\text{mm}$ in distance from any other scratch or foreign object is ignored. 长 $\leq 20\text{mm}$ , 并与另一刮花或杂物之间的距离 $> 40\text{mm}$ , 可以忽略; $L \leq 20\text{mm}$ , the scratch that is $< 40\text{mm}$ in distance from any other scratch or foreign object. The TP is regarded as a defect 长 $\leq 20\text{mm}$ , 并与另一刮花或杂物之间的距离 $< 40\text{mm}$ , 则 TP 属不良品; $L > 20\text{mm}$ the TP is regarded as a defect. 长 $> 20\text{mm}$ 的 TP 属不良品;
$W > 0.05\text{mm}$ 宽 $> 0.05\text{mm}$	The T/P is regarded as a defect. T/P 属不良品。

### 2.4-6 Fish eye on film, Dent on film and Air bubble

film上的鱼眼、凹痕、气泡

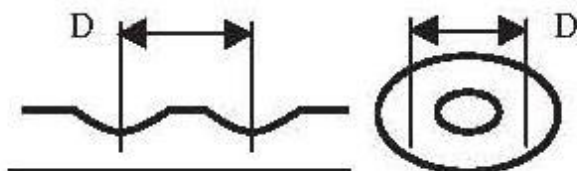

A:  $D \leq 0.2$

B:  $0.2 < D \leq 0.4$

C:  $0.4 < D \leq 0.5$

E:  $D > 0.5$

D(mm): average diameter = (Long dia. + short dia.) / 2

A: 直径  $\leq 0.2$

B:  $0.2 < \text{直径} \leq 0.4$

C:  $0.4 < \text{直径} \leq 0.5$

E: 直径  $> 0.5$

D(mm): 平均直径 = (长径 + 短径) / 2

A: Ignored

B: 5 or less

C: 2 or less

E: Zero

A: 可忽略

B:  $\leq 5$

C:  $\leq 2$

E: 0

### 2.4-7 Newton's ring:

牛顿环:

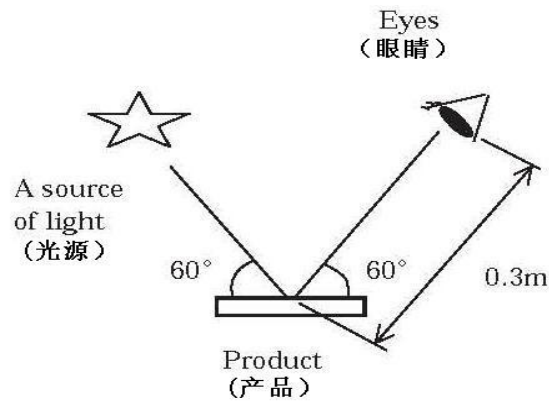

Visual inspection shall be done at a distance of 0.3 m between eyes and a product with an angles of  $60^\circ \pm 10^\circ$  to the surface of the product under a ceiling fluorescent light (40 W, natural color). An environmental condition for judge is at  $23^\circ\text{C} \pm 5^\circ\text{C}$ ,  $55\% \text{RH} \pm 10\% \text{RH}$  and 860 h Pa to 1060 h Pa. This standard shall be applied to the initial status.

在荧光灯（40W，自然光）下目测，目测距离为 0.3m 并且成  $60^\circ \pm 10^\circ$  角检测产品。此产品可在温度  $23^\circ\text{C} \pm 5^\circ\text{C}$ ，湿度  $55\% \text{RH} \pm 10\% \text{RH}$ ，气压 860hPa-1060hPa 的环境下判定测试，此标准适用于产品的初期状态。

牛顿环分为两种：

1. Regular 规律性：

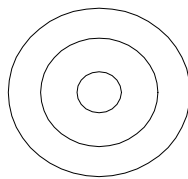

A When Newton ring dimension is more than 1/3 of sample dimension; it is regarded as a defect.

当 T/P 产生的牛顿环面积大小超过整个 T/P 面积的 1/3 时，判定为不良品。

B When Newton ring dimension that is less than 1/3 of sample dimension and is not affect font effect and line distortion under a ceiling fluorescent light, it is acceptable.

当 T/P 产生的牛顿环面积小于整个 T/P 面积的 1/3 且点灯后不影响文字及直线失真，可以接受。

2. Irregular 非规律性：

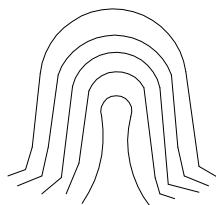

A Newton ring dimension is more than 1/2 without lighting; it is regarded as a defect.

牛顿环不点灯下超过 1/2，判定为不良品。

B As long as Newton ring affects font effect and line distortion under a ceiling fluorescent light, it is regarded as a defect.

不论大小点灯后，造成文字失真或直线变形，判定为不良品。

C When Newton ring dimension is less than 1/2 of sample dimension and is not affect font effect and line distortion under a ceiling fluorescent light, it is acceptable.

当牛顿环面积小于整个 T/P 面积的 1/2 时且点灯后，不影响文字及直线失真，可以接受。

## 2.4-8 Air-bubble of OCA inspection standard (assemble overlay with OCA) OCA 的

气泡检验标准(用透明胶组合面版)

\*According to T/P+OCA+OVERLAY type:

\*针对 T/P+透明胶+面版结构的触摸屏:

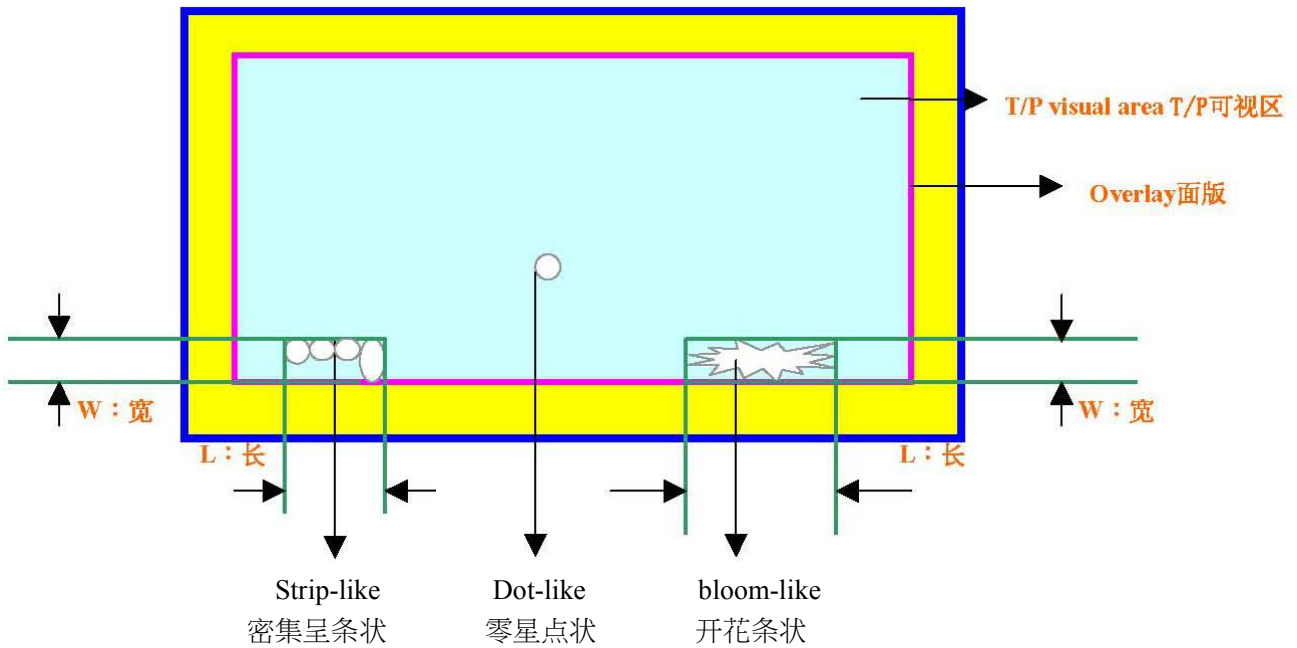

### A) Dot-like air-bubble (anywhere in visual area)

零星点状气泡（一般随机分布TP可视区内）D=diameter直径

CRITERIA	DECISION
$D \leq 0.3\text{mm}$ 直径 $\leq 0.3\text{mm}$	Ignored 可忽略
$0.3\text{mm} \leq D \leq 0.5\text{mm}$ $0.3\text{mm} \leq \text{直径} \leq 0.5\text{mm}$	The air-bubble that is $>20\text{mm}$ in distance from any other air-bubble is ignored. 如果与另一气泡的距离 $>20\text{mm}$ ，则可忽略。
$D > 0.5\text{mm}$ 直径 $> 0.5\text{mm}$	The T/P is regarded as a defect. T/P 属不良品



B) Strip-like or bloom-like air-bubble (near edge of overlay)

密集成条状或开花状汽泡（一般靠近overlay边缘）

W=width of all strip-like air-bubbles 宽(条状汽泡外径到面版边缘进入可视区距离)

CRITERIA	DECISION
<p>W≤0.5mm 宽≤0.5mm</p>	<p>Ignored 可忽略</p>
<p>W : 0.5mm~1mm 宽在0.5mm~1mm之内</p>	<p>L≤20mm, the strip-like or bloom-like air-bubble that is &gt;20mm in distance from any strip-like or bloom-like air-bubble is ignored. 如果 L≤20mm 且与另一条密集汽泡或开花状汽泡的间距&gt;20mm, 则可忽略不计。 L≤20mm, the strip-like or bloom-like air-bubble is &lt;20mm in distance from any strip-like or bloom-like air-bubble. Two air-bubbles along each edge are allowed. 如果 L≤20mm 且与另一条密集或开花状汽泡的距离&lt;20mm, 则四边每边最多允许有 2 条。 L&gt;20mm, only one air-bubble each edge is allowed. 如果 L&gt;20mm, 则四边每边最多允许有 1 条。</p>
<p>W&gt;1mm 宽&gt;1mm</p>	<p>The T/P is regarded as a defect. T/P 属不良品。</p>

**2.4-9 others:** This specification is considered as basic on the products, but details are subject to discussion upon individual customer requirement.

其它： 此承认书基本满足产品特性要求，若有其它问题可针对客户实际要求进行协商。

**3 Reliant Condition** 信赖性条件

**3.1 Temperature condition** 环境条件

**3.1-1 Temperature and Humidity resistance Test** 耐高温高湿测试：

The requirements in “Operation force”、 “Light transparency” of the item “1.5 Mechanical characteristics” and “1.6 Electric characteristics” shall be satisfied after exposing samples at 60 °C ,90 %RH for 120h by 1cycle,and each item should be measured after exposing them in normal temperature and humidity for 24h.

将产品放置在 60℃, 90%RH 持续 120 小时做一个循环，然后在常温常湿下放置 24 个小时后进行测试。产品满足 “1.5 机械性能” 里的 “操作压力”、 “透光率” 和 “1.6 电器性能” 项目要求。

**3.1-2 Heat resistance** 耐热性：

The requirements in “Operation force”、 “Light transparency” of the item “1.5 Mechanical characteristics” and “1.6 Electric characteristics” shall be satisfied after exposing samples at 70 °C for 120h, and each item should be measured after exposing them in normal temperature and humidity for 24h.

将产品放置在 70℃持续 120 小时，然后在常温常湿下放置 24 个小时后进行测试。产品满足“1.5 机械性能” 里的 “操作压力” 、 “透光率” 和 “1.6 电器性能” 项目要求。

### 3.1-3 Cold resistance 耐寒性:

The requirements in “Operation force”、 “Light transparency” of the item “1.5 Mechanical characteristics” and “1.6 Electric characteristics” shall be satisfied after exposing samples at  $-20^{\circ}\text{C}$  for 120h, and each item should be measured after exposing them in normal temperature and humidity for 24 h.

将产品放置在 $-20^{\circ}\text{C}$ 持续 120 小时，然后在常温常湿下放置 24 个小时后进行测试。产品满足“1.5 机械性能”里的“操作压力”、“透光率”和“1.6 电器性能”项目要求。

### 3.1-4 Thermal shock 冷热冲击:

The requirements in “Operation force”、 “Light transparency” of the item “1.5 Mechanical characteristics” and “1.6 Electric characteristics” shall be satisfied after exposing samples at  $-20^{\circ}\text{C}$  (4 h)  $\Leftrightarrow$   $60^{\circ}\text{C}$  (4 h) by 3 cycles and each item should be measured after exposing them in taking out the samples normal temperature and humidity for 24 h. from a chamber (as the following chart) .

将产品放置在 $-20^{\circ}\text{C}$  (4h)  $\Leftrightarrow$   $60^{\circ}\text{C}$  (4h) 下做 3 个循环，然后待产品常温常湿下放置 24 个小时后，再取出进行测试。产品满足“1.5 机械性能”里的“操作压力”、“透光率”和“1.6 电器性能”项目要求（如下图所示）。

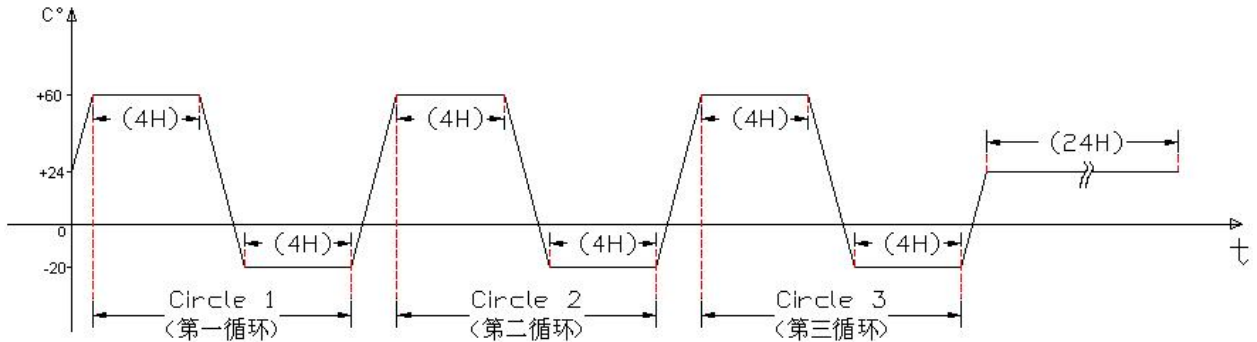

## 4 Precautions in use 使用过程中的注意事项

In order to prevent accidental use and performance deterioration, please keep the following precautions and inhibited points.

为了避免不良事故的发生和产品性能的破坏，请遵守如下警告及禁止事项。

### 4.1 Cautions for storage 储存的注意事项:

Store the products at the temperature and humidity mentioned in the specification in a state storage of package with care not to expose the products to the direct sunlight or stresses.

储存产品时须按样品承认书的温湿度要求放置，注意不可受日光直射或重物重压。

### 4.2 Cautions for unpacking 卸货的注意事项:

Please advert to direction of the product packing before unpacking

卸货前请注意产品外包装的方向性。

### 4.3 Cautions for handling 搬运的注意事项:

1) Transparency is an important factor for the product. So, please wear clean finger sacks, gloves and mask to protect the products from fingerprint or stain attach, and also hold the portion outside the view area when handling the panel.

须保持产品的透明清晰度，因而请在接触产品之前戴上清洁的指套、手套和面罩以免留下指纹或污点，并且握拿产品时请握住产品的四周。

2) Please use finger sacks or gloves to avoid injuries by sharp edges when handling the Film-Glass type touch panel because a glass edges are not chamfered.

当握拿Film-Glass类型的产品时，请戴上指套或手套以免锐利部分刺伤手指，因为玻璃四周没有磨边。

**【Inhibition】 【禁止事项】：**

- Do not handle the product by holding the flexible pattern portion in order to assure the reliability.
- 在取出产品时，请勿握拿引线以免造成产品与引线松动。
- Do not put one product on the other. Otherwise, it may cause the product to be scratched and/or change on cosmetic occur.
- 请勿将产品叠放，以免引起刮花造成产品外观不良。
- Do not put a heavy, hard or sharp object on the product.
- 请勿将重物、硬物、尖物压于产品上。

**4.4 Cautions for installing and assembling** 组合上机的注意事项

1) Do not give excessive strain to the product.

不要对产品施加额外的拉力。

2) Flexible pattern cable is connected to the body by heat-seal (thermal pressure) method. So, do not apply excessive forces to the flexible pattern.

因为引线连接采用的是热压组合方式，所以不要使用额外的拉力。

**【Inhibition】 【禁止事项】**

Do not add an excessive force to a FPC (Flex tail) that makes peeling off of the FPC from the product as the manner shown in the following figures:

安装组合时，请勿重拉 FPC，因为重拉将使 FPC 易从产品上剥离，习惯拉扯方式如图：

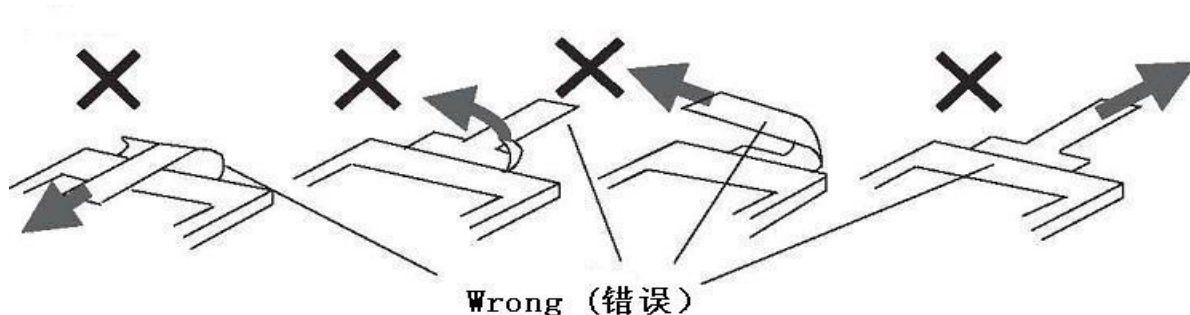

Do not fix, adhere or mount any additional goods on the FPC such as additional film/plate on the FPC as shown in below, because such additional goods emphasizes a stress applied at the tip of FPC and it works tearing off the root of FPC from touch panel.

请勿在 FPC 上粘贴或安装其它物品。如：在 FPC 上贴一层 film 或金属板（如图），因为这些附加物会对 FPC 顶部施加一个额外的压力，从而导致 FPC 内侧松动。

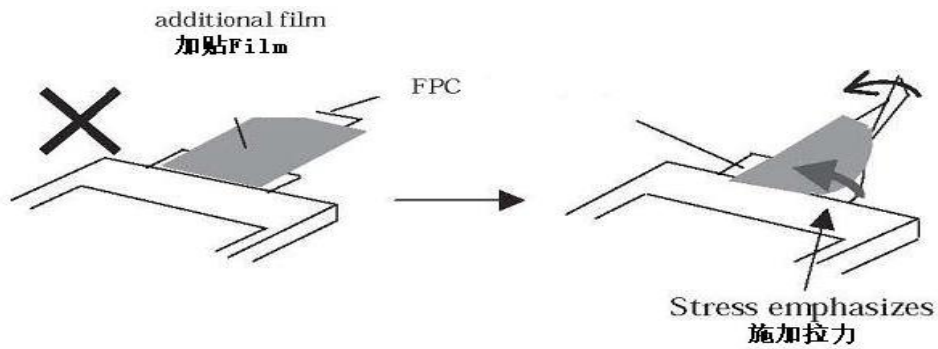

3) The transparent touch panel is provided with an air groove. Therefore please design the structure not to store any liquid or any fine particles near it.

T/P若有通气槽，请在设计产品结构时，注意产品附近不能有液体物和粉状物。

4) In order not to apply load on the surface of the touch panel, please keep a clearance of 0.2mm-0.5mm between product and case.

为了避免T/P表面受压，因此机壳与我司T/P组合间隙须保持在0.2mm-0.5mm的范围内。

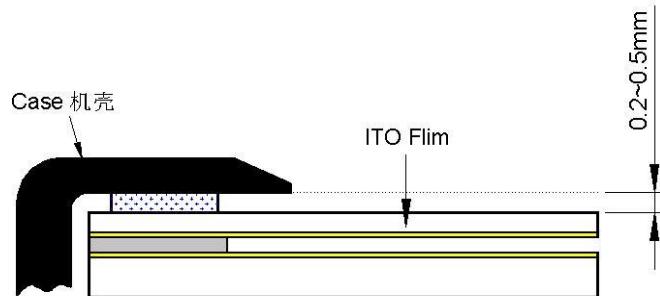

5) We recommend to design a case that it covers the boundary of the active area inside in order to prevent an operation at outside of the active area which can not guarantee the specified durability, because operation at the outside of the active area causes serious damage of a transparent electrode.

我们建议设计机壳应覆盖驱动区的边缘，以免对驱动区外区域进行操作，减少寿命，因为驱动区外区域操作会严重损伤透明电极。

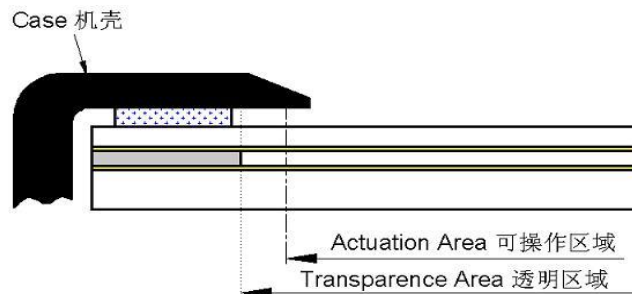

6) a. Pressing inside of boundary of the frame(part (A) as shown in below) may causes fault operation, so please design to avoid pressing of touch panel at part (A) such as having gasket/cushion at part (C). Particularly the area (B) shall be free from burr. The gasket/cushion material at the part (C) should not be exceeded to inside of the boundary of the frame.

图中的A为敏感区，此区域易产生误操作，为了避免此类操作可在T/P的A部分设计一个缓冲层/泡棉如图C。特别是图中B区域不能有震荡。缓冲层/泡棉应在图C的边缘上内缩，不可超过绝缘边。

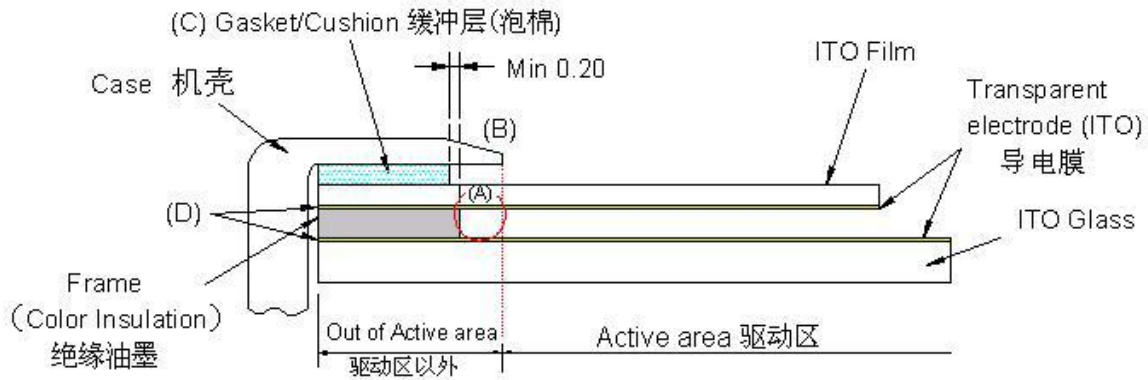

Please do not make the following mistake:

请勿犯如下错误:

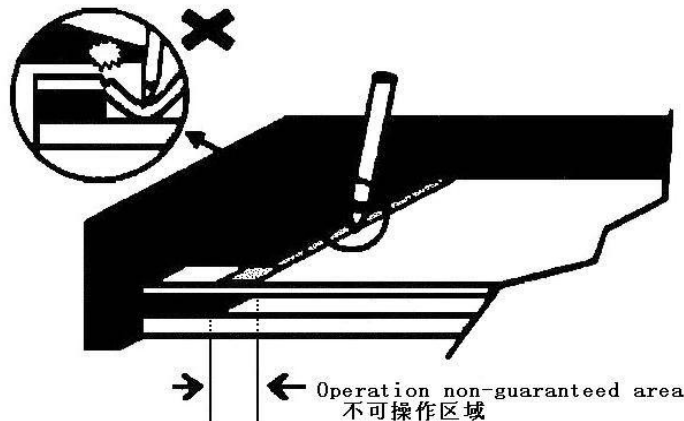
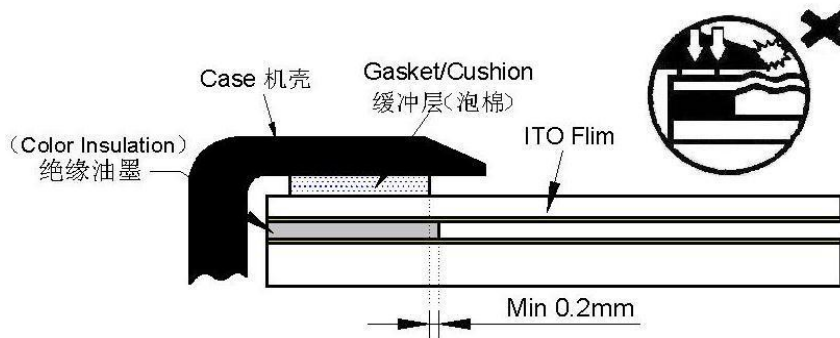

b. Since ITO of film and glass is not eliminated at the edge, therefore please design as any conductive material does not touch the edge of touch panel.

因为 film 和 glass 走线边缘仍有 ITO 导电膜，所以在设计时在它们边缘都不能有类似的导电材料，以免造成电极间相互影响，破坏电器性能。

**【Inhibition】 【禁止事项】：**

To prevent giving distortion to the film of the product and peeling off of the film from the product, do not fix the film and a set case or a shock absorbing material adhered to a set case by adhesion.

为了防止 film 变形及易从产品上撕落，请勿用粘胶将 film 与机壳或防震材料组合上机。

- 7) When designing installment of case and touch panel, you would better consider to keep clearance of 0.2-0.3mm between touch panel and inside boundary of case.  
 当设计机壳与T/P组装时，T/P外形与机壳内缘距离最好控制在0.2-0.3mm以内。

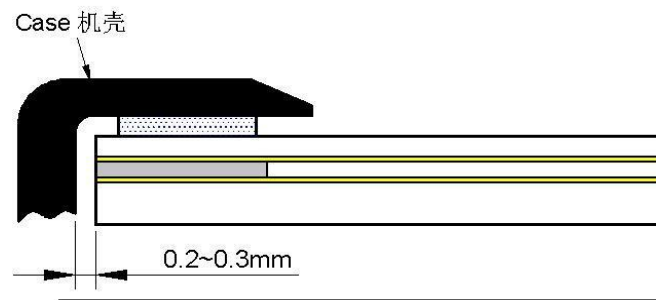

Meanwhile, in order to avoid touch panel any failure for extra wrap tail, please take care of keeping clearance of 2.0mm between tail position and inside boundary of case when the touch panel is built into case.  
 同时，当T/P组合上机时，为了避免过度弯折引出线造成产品功能不良，请慎重保持T/P引出线的位置与机壳内缘距离最小2.0mm。

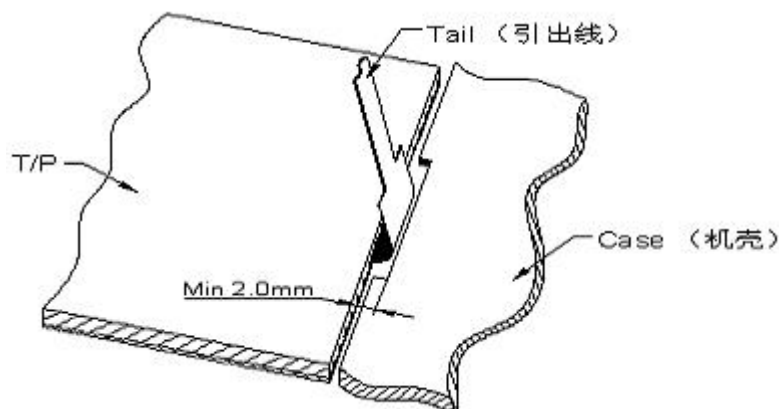

- 8) Please keep your case flat in order not to touch with touch panel directly, which causes serious damage of a transparent electrode.  
 请保持机壳平整，以免机壳与T/P直接接触而导致透明电极损坏。

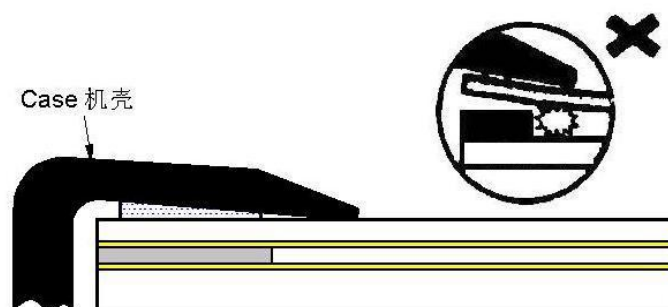

- 9) Wipe off the stain on the product by using soft cloth moistened with ethanol.  
 Take care not to allow ethanol to soak into the joint of upper Film and bottom glass. It may otherwise cause peeling or defective operation.  
 用浸湿过酒精的软布擦去产品表面的污秽，小心酒精渗入上线 film 和下线 glass 之间，否则附着力不强易产生剥离或操作不良。

**【Inhibition】 【禁止事项】：**

Do not use any organic solvent or detergent other than ethanol.

请勿使用酒精以外的任何有机溶剂或清洗剂。

- 10) The corners of the product are not chamfered. When positioning and fixing the product on the case, we suggest that you would provide an “R” part on the corner of the case so as not to apply load on the corner of the transparent touch panel.

产品的每个角落请勿倾斜。当产品定位组合上机时，我们建议贵方可以在设计机壳时，将机壳四角设计为“R”角形来固定产品，以致不会对产品的四角施加压力。

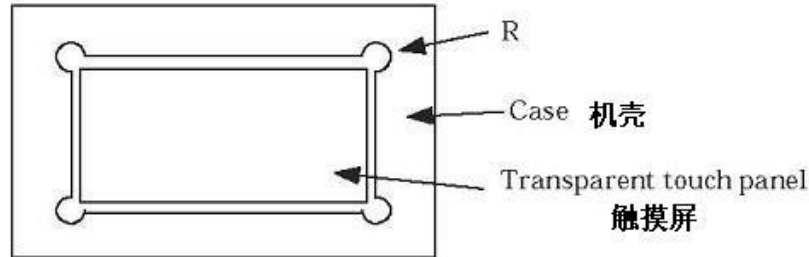

**【Inhibition】 【禁止事项】：**

Do not press the film of the product when this product is built into a set.

当产品组合上机后，请勿按压。

- 11) Please confirm its characteristic in advance whether any damage is given to this product when attaching a protection sheet on this product at customer side. Some changes may arise in the characteristics of this product by the protection sheet attachment such as operation, cosmetic, etc. However, those changes are out of our guarantee.

当需在产品上加贴客户方提供的保护膜时，请务必提前确定在产品上加贴保护膜是否会毁坏产品本身的特性。如果产品通过加贴保护膜，产品的特性可能会产生许多变化如：操作性能、外观等等，但是这些情况的出现我们不予保证。

Even when attaching a protection sheet with adhesion material by our side based on the request from customer, some changes may arise in the characteristics of this product by the protection sheet attachment such as operation, cosmetic, etc.. However, those changes are out of our guarantee.

甚至若按客户要求需加贴我司带胶的保护膜时，如果产品通过加贴保护膜时，产品的特性可能会有许多变化如：操作性能、外观等等，但是这些情况的出现我们将不予保证。

- 12) When this product is attached on LCD or other target by using a double-sided tape etc., put an enough pressure onto the non-active area (Frame) of a touch panel so that neither exfoliation nor gap may take place between a touch panel and LCD or other target. As attachment, please apply pressure equally onto the corner part and four sides of a touch panel. There is a case to take a time being for conducting an original adhesion, therefore, please does not move the product after attachment.

当使用双面胶等将产品与LCD或其它机器组合时，请使用充分的力按压T/P的非动作区从而使T/P与LCD或其它机器粘合既无脱落又无空隙。当组合时，请平衡压合T/P角落和四周，由于T/P与机壳组合时起初粘合需一定的时间，所以当产品起初粘合好后，请勿接触产品。

#### **4.5 Cautions for operation 操作时的注意事项**

- 1) Operate it with a polyacetal pen (tip  $\phi 2$  or over) or a belly of a finger without applying operation excessive load.

请使用聚纤维酯笔（笔尖 $\geq \phi 2$ ）或手指，而勿用太大的力进行操作

**【Inhibition】 【禁止事项】**

Do not operate by other than polyacetal pen(tip  $\phi$  2 or over) and/or a belly of a finger like a hard or a sharp edges such as a ball point pen, sharp pencil, sharp tiptoe, etc.

请勿用聚纤维酯笔  $\phi$  2 的笔头（笔尖  $\geq \phi$  2）或手指以外的物体来操作，如：硬而尖的物体像圆珠笔、尖铅笔、尖指甲等等。

- 2) The input position may be fluctuated a little through long-time use. It is desirable to provide a zero-adjustment function by using a circuit and software.

由于长期使用，点击按键的位置很可能会有略微的上下偏移，因此建议最好使用电流和软件的形式进行归零操作。

- 3) Use ethanol to remove stain from the product surface. If ethanol soaks into the joint of upper film and bottom glass, it may cause peeling and defective operation.

用酒精去除产品表面的污秽。如果有酒精泡沫移留在film和glass之间，很可能粘着力不强，引起脱落或操作不良。

**【Inhibition】 【禁止事项】**

Do not use alkaline detergents including glass cleaner, manicure remover (toluene), benzine or other organic solvents.

请勿使用有机溶剂，包括：玻璃清洗剂，去除剂，汽油或其它有机溶剂。

- 4) Operation at the out of Active Area is out of our guarantee. Because failing operation will damage surface transparent electrode badly.

我司不保证驱动区外侧的操作原因是：此操作对导电膜会有严重的损坏。

**【Inhibition】 【禁止事项】**

Do not operate at the out of Active Area.

请勿在驱动区外操作。

- 5) In case of cleaning the part of the case boundary of accomplished set, use a soft cloth or a cotton bud.

假若需清洗组装好后的机壳边缘部分，请使用棉布或棉棒进行擦拭。

**【Inhibition】 【禁止事项】：**

Do not clean with a thing other than the finger such as hard or sharp edges like a finger nail etc. on the cloth, because it cause transparent conductive film cracks.

Please advise this inhibition to your last customers.

请勿使用指肚以外的物体如用硬而尖的物体，如：套上棉布的尖指甲等，因为它会引起上线透明导电面 film 的损坏。请提醒您的终端客户注意。

**4.6 Other cautions 其它注意事项**

- 1) Please note that dew gathering in the panel due to abrupt temperature or humidity change, etc. May cause deterioration of performance.

由于环境温湿状态易发生变化，因此请保持产品勿结露，因为产品结露会引起产品的性能严重劣化。

- 2) (※In case of Film/Glass type)The glass of products may break due to a set's drop or overload on the panels (It is difficult to avoid the break by nature.). Besides, the broken glass may cause injuries. Therefore, take care not to break the glass of products when handling the set, and add the following notes.

- When handling the product, take care not to break the transparent touch panel.
- In case the product is broken, do not touch the panel bare-handed to prevent injuries.

(※假若为 Film+Glass 类型) 因为机器设备跌落或超压很可能会引起玻璃的破裂（一般很难避免破损），玻璃破损又可能会引起割伤，所以搬移机器设备时，请小心勿使 T/P 的玻璃破碎，同时增加以下注意事项。



- 当取出产品时，切记勿碎 T/P。
- 一旦产品破碎时，勿用空手直接接触产品以免割伤。

3) When this product was built into the set, if there is vulcanization material such as vulcanized rubber which has a possibility of generating the sulfuration gas near the set, since abnormalities will be caused to wiring of the product and it will become the cause of functional degradation, please give a constitutional cautions.

当产品组合上机时，若有硫性材料如硫化橡胶，这种材料在机壳附近可能会引起硫化反应，正因为这种异常现象的出现从而导致产品的线性紊乱，功能下降，请务必谨慎。

4) Caution for product safety set 产品安全配置注意事项：

Although full care is taken to ensure product quality, failure modes such as degradation, short circuits, or open circuits might be caused. Therefore, to design a product set, please study the affects of any single failure of the panel in advance and consider the safety of product configuration.

虽然我司很谨慎地保证产品的品质，但是还会有像功能下降、断路、短路现象出现的可能。因此，贵方在设计产品装置的同时，请预先要研究引起产品功能不良的因素，并且要考虑产品的配置安全性。

## **5 Handling of product specification for information 样品承认书反馈**

1) This specification shall guarantee the quality of the panel alone. For actual use, be sure to check and evaluate the product set with the panel installed in your equipment.

此样品承认书只论证产品的品质保证。为实际上机使用，请检查和评估我司产品组合贵方机器设备的配置状况。

2) After evaluation, please put your approval stamp on our submitted specification and return us two copies of the specification. In case the copies are not returned to us even 1 months after the issued date described in the specification, we will regard that you have approved the contents of the specification.

当贵方评估后，请贵方在我司的承认书上盖上确认图章，并且将两份附本寄回我司，倘若在承认书制作日期后甚至 1 个月，副本未达至我司，我们将仍敬候贵方能确认我司的样品承认书。

3) Any change of the specification is subject to discussion prior to the actual changes.

样品承认书变更内容需针对实际情况进行协商变更。

## **6 Attachment 附件**

### **6.1 Engineering drawing 工程图**

