

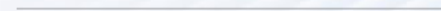

CONTENTS

- / 01. **Company Profile**
- / 02. **Product Display**
- / 03. **Technology**
- / 04. **Features & Functions**





Company Profile

01

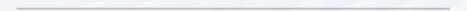

Certification

ETL

UPC

FCC

CE-LVD

CE-EMC

intertek AUTHORIZATION TO MARK

This authorizes the application of the Certification Mark(s) shown below to the models described in the Product(s) Covered section when made in accordance with the conditions set forth in the Certification Agreement and Listing Report. This authorization also applies to multiple listed model(s) identified on the correlation page of the Listing Report.

This document is the property of Intertek Testing Services and is not transferable. The certification mark(s) may be applied only at the location of the Party Authorized to Apply Mark.

Applicant: Tejer Technology Co., Ltd. **Manufacturer:** Tejer Technology Co., Ltd.
Address: 128 Halliang Road, Sanjia Subdistrict, Zhejiang, Taizhou, Zhejiang, 318000 **Address:** 128 Halliang Road, Sanjia Subdistrict, Zhejiang, Taizhou, Zhejiang, 318000
Country: China **Country:** China

Party Authorized to Apply Mark: Same as Manufacturer
Report Issuing Office: Intertek Testing Services Ltd, Zhejiang
Control Number: 2311271 **Authorized by:** for L. Matthew Snyder, Certification Manager

ETL

This document represents all product Authorizations to Mark for the noted Report Number.

Personal Hygiene and Health Care Appliances (UL 1431:2011 Ed. 3R1:30Apr2024)
Electrical Plumbing Accessories (UL 1961:2011 Ed. 2:17Jun2020)
Motor Operated Appliances (Household and Commercial) (QD 919) (CSA C22.3W8.2018 Ed. 8:U1:10)
Household Cooling and Liquid-Heating Appliances (CSA C22.284.2:019 Ed. 8)

Models: TA-X560, TA-X560LD, TA-X560DF, TA-X565, TA-X565LD, TA-X565DF, TA-X565DF-8, TA-X567, TA-X567LD, TA-X567DF, TA-X568, TA-X568LD, TA-X568DF, TA-X568DF-8, TA-X570, TA-X570LD, TA-X570DF, TA-X571, TA-X571LD, TA-X571DF, TA-X572, TA-X572LD, TA-X572DF, TA-X573, TA-X573LD, TA-X573DF, TA-X574, TA-X574LD, TA-X574DF, TA-X575, TA-X575LD, TA-X575DF, TA-X576, TA-X576LD, TA-X576DF, TA-X577, TA-X577LD, TA-X577DF, TA-X578, TA-X578LD, TA-X578DF, TA-X579, TA-X579LD, TA-X579DF, TA-X580, TA-X580LD, TA-X580DF, TA-X585, TA-X585LD, TA-X585DF, TA-X585DF-8, TA-X587, TA-X587LD, TA-X587DF, TA-X588, TA-X588LD, TA-X588DF, TA-X588DF-8, TA-X590, TA-X590LD, TA-X590DF, TA-X595, TA-X595LD, TA-X595DF, TA-X595DF-8, TA-X597, TA-X597LD, TA-X597DF, TA-X598, TA-X598LD, TA-X598DF, TA-X598DF-8, TA-X599, TA-X599LD, TA-X599DF, TA-X600, TA-X600LD, TA-X600DF, TA-X605, TA-X605LD, TA-X605DF, TA-X605DF-8, TA-X607, TA-X607LD, TA-X607DF, TA-X608, TA-X608LD, TA-X608DF, TA-X608DF-8, TA-X610, TA-X610LD, TA-X610DF, TA-X615, TA-X615LD, TA-X615DF, TA-X615DF-8, TA-X617, TA-X617LD, TA-X617DF, TA-X618, TA-X618LD, TA-X618DF, TA-X618DF-8, TA-X620, TA-X620LD, TA-X620DF, TA-X625, TA-X625LD, TA-X625DF, TA-X625DF-8, TA-X627, TA-X627LD, TA-X627DF, TA-X628, TA-X628LD, TA-X628DF, TA-X628DF-8, TA-X630, TA-X630LD, TA-X630DF, TA-X635, TA-X635LD, TA-X635DF, TA-X635DF-8, TA-X637, TA-X637LD, TA-X637DF, TA-X638, TA-X638LD, TA-X638DF, TA-X638DF-8, TA-X640, TA-X640LD, TA-X640DF, TA-X645, TA-X645LD, TA-X645DF, TA-X645DF-8, TA-X647, TA-X647LD, TA-X647DF, TA-X648, TA-X648LD, TA-X648DF, TA-X648DF-8, TA-X650, TA-X650LD, TA-X650DF, TA-X655, TA-X655LD, TA-X655DF, TA-X655DF-8, TA-X657, TA-X657LD, TA-X657DF, TA-X658, TA-X658LD, TA-X658DF, TA-X658DF-8, TA-X660, TA-X660LD, TA-X660DF, TA-X665, TA-X665LD, TA-X665DF, TA-X665DF-8, TA-X667, TA-X667LD, TA-X667DF, TA-X668, TA-X668LD, TA-X668DF, TA-X668DF-8, TA-X670, TA-X670LD, TA-X670DF, TA-X675, TA-X675LD, TA-X675DF, TA-X675DF-8, TA-X677, TA-X677LD, TA-X677DF, TA-X678, TA-X678LD, TA-X678DF, TA-X678DF-8, TA-X680, TA-X680LD, TA-X680DF, TA-X685, TA-X685LD, TA-X685DF, TA-X685DF-8, TA-X687, TA-X687LD, TA-X687DF, TA-X688, TA-X688LD, TA-X688DF, TA-X688DF-8, TA-X690, TA-X690LD, TA-X690DF, TA-X695, TA-X695LD, TA-X695DF, TA-X695DF-8, TA-X697, TA-X697LD, TA-X697DF, TA-X698, TA-X698LD, TA-X698DF, TA-X698DF-8, TA-X700, TA-X700LD, TA-X700DF, TA-X705, TA-X705LD, TA-X705DF, TA-X705DF-8, TA-X707, TA-X707LD, TA-X707DF, TA-X708, TA-X708LD, TA-X708DF, TA-X708DF-8, TA-X710, TA-X710LD, TA-X710DF, TA-X715, TA-X715LD, TA-X715DF, TA-X715DF-8, TA-X717, TA-X717LD, TA-X717DF, TA-X718, TA-X718LD, TA-X718DF, TA-X718DF-8, TA-X720, TA-X720LD, TA-X720DF, TA-X725, TA-X725LD, TA-X725DF, TA-X725DF-8, TA-X727, TA-X727LD, TA-X727DF, TA-X728, TA-X728LD, TA-X728DF, TA-X728DF-8, TA-X730, TA-X730LD, TA-X730DF, TA-X735, TA-X735LD, TA-X735DF, TA-X735DF-8, TA-X737, TA-X737LD, TA-X737DF, TA-X738, TA-X738LD, TA-X738DF, TA-X738DF-8, TA-X740, TA-X740LD, TA-X740DF, TA-X745, TA-X745LD, TA-X745DF, TA-X745DF-8, TA-X747, TA-X747LD, TA-X747DF, TA-X748, TA-X748LD, TA-X748DF, TA-X748DF-8, TA-X750, TA-X750LD, TA-X750DF, TA-X755, TA-X755LD, TA-X755DF, TA-X755DF-8, TA-X757, TA-X757LD, TA-X757DF, TA-X758, TA-X758LD, TA-X758DF, TA-X758DF-8, TA-X760, TA-X760LD, TA-X760DF, TA-X765, TA-X765LD, TA-X765DF, TA-X765DF-8, TA-X767, TA-X767LD, TA-X767DF, TA-X768, TA-X768LD, TA-X768DF, TA-X768DF-8, TA-X770, TA-X770LD, TA-X770DF, TA-X775, TA-X775LD, TA-X775DF, TA-X775DF-8, TA-X777, TA-X777LD, TA-X777DF, TA-X778, TA-X778LD, TA-X778DF, TA-X778DF-8, TA-X780, TA-X780LD, TA-X780DF, TA-X785, TA-X785LD, TA-X785DF, TA-X785DF-8, TA-X787, TA-X787LD, TA-X787DF, TA-X788, TA-X788LD, TA-X788DF, TA-X788DF-8, TA-X790, TA-X790LD, TA-X790DF, TA-X795, TA-X795LD, TA-X795DF, TA-X795DF-8, TA-X797, TA-X797LD, TA-X797DF, TA-X798, TA-X798LD, TA-X798DF, TA-X798DF-8, TA-X800, TA-X800LD, TA-X800DF, TA-X805, TA-X805LD, TA-X805DF, TA-X805DF-8, TA-X807, TA-X807LD, TA-X807DF, TA-X808, TA-X808LD, TA-X808DF, TA-X808DF-8, TA-X810, TA-X810LD, TA-X810DF, TA-X815, TA-X815LD, TA-X815DF, TA-X815DF-8, TA-X817, TA-X817LD, TA-X817DF, TA-X818, TA-X818LD, TA-X818DF, TA-X818DF-8, TA-X820, TA-X820LD, TA-X820DF, TA-X825, TA-X825LD, TA-X825DF, TA-X825DF-8, TA-X827, TA-X827LD, TA-X827DF, TA-X828, TA-X828LD, TA-X828DF, TA-X828DF-8, TA-X830, TA-X830LD, TA-X830DF, TA-X835, TA-X835LD, TA-X835DF, TA-X835DF-8, TA-X837, TA-X837LD, TA-X837DF, TA-X838, TA-X838LD, TA-X838DF, TA-X838DF-8, TA-X840, TA-X840LD, TA-X840DF, TA-X845, TA-X845LD, TA-X845DF, TA-X845DF-8, TA-X847, TA-X847LD, TA-X847DF, TA-X848, TA-X848LD, TA-X848DF, TA-X848DF-8, TA-X850, TA-X850LD, TA-X850DF, TA-X855, TA-X855LD, TA-X855DF, TA-X855DF-8, TA-X857, TA-X857LD, TA-X857DF, TA-X858, TA-X858LD, TA-X858DF, TA-X858DF-8, TA-X860, TA-X860LD, TA-X860DF, TA-X865, TA-X865LD, TA-X865DF, TA-X865DF-8, TA-X867, TA-X867LD, TA-X867DF, TA-X868, TA-X868LD, TA-X868DF, TA-X868DF-8, TA-X870, TA-X870LD, TA-X870DF, TA-X875, TA-X875LD, TA-X875DF, TA-X875DF-8, TA-X877, TA-X877LD, TA-X877DF, TA-X878, TA-X878LD, TA-X878DF, TA-X878DF-8, TA-X880, TA-X880LD, TA-X880DF, TA-X885, TA-X885LD, TA-X885DF, TA-X885DF-8, TA-X887, TA-X887LD, TA-X887DF, TA-X888, TA-X888LD, TA-X888DF, TA-X888DF-8, TA-X890, TA-X890LD, TA-X890DF, TA-X895, TA-X895LD, TA-X895DF, TA-X895DF-8, TA-X897, TA-X897LD, TA-X897DF, TA-X898, TA-X898LD, TA-X898DF, TA-X898DF-8, TA-X900, TA-X900LD, TA-X900DF, TA-X905, TA-X905LD, TA-X905DF, TA-X905DF-8, TA-X907, TA-X907LD, TA-X907DF, TA-X908, TA-X908LD, TA-X908DF, TA-X908DF-8, TA-X910, TA-X910LD, TA-X910DF, TA-X915, TA-X915LD, TA-X915DF, TA-X915DF-8, TA-X917, TA-X917LD, TA-X917DF, TA-X918, TA-X918LD, TA-X918DF, TA-X918DF-8, TA-X920, TA-X920LD, TA-X920DF, TA-X925, TA-X925LD, TA-X925DF, TA-X925DF-8, TA-X927, TA-X927LD, TA-X927DF, TA-X928, TA-X928LD, TA-X928DF, TA-X928DF-8, TA-X930, TA-X930LD, TA-X930DF, TA-X935, TA-X935LD, TA-X935DF, TA-X935DF-8, TA-X937, TA-X937LD, TA-X937DF, TA-X938, TA-X938LD, TA-X938DF, TA-X938DF-8, TA-X940, TA-X940LD, TA-X940DF, TA-X945, TA-X945LD, TA-X945DF, TA-X945DF-8, TA-X947, TA-X947LD, TA-X947DF, TA-X948, TA-X948LD, TA-X948DF, TA-X948DF-8, TA-X950, TA-X950LD, TA-X950DF, TA-X955, TA-X955LD, TA-X955DF, TA-X955DF-8, TA-X957, TA-X957LD, TA-X957DF, TA-X958, TA-X958LD, TA-X958DF, TA-X958DF-8, TA-X960, TA-X960LD, TA-X960DF, TA-X965, TA-X965LD, TA-X965DF, TA-X965DF-8, TA-X967, TA-X967LD, TA-X967DF, TA-X968, TA-X968LD, TA-X968DF, TA-X968DF-8, TA-X970, TA-X970LD, TA-X970DF, TA-X975, TA-X975LD, TA-X975DF, TA-X975DF-8, TA-X977, TA-X977LD, TA-X977DF, TA-X978, TA-X978LD, TA-X978DF, TA-X978DF-8, TA-X980, TA-X980LD, TA-X980DF, TA-X985, TA-X985LD, TA-X985DF, TA-X985DF-8, TA-X987, TA-X987LD, TA-X987DF, TA-X988, TA-X988LD, TA-X988DF, TA-X988DF-8, TA-X990, TA-X990LD, TA-X990DF, TA-X995, TA-X995LD, TA-X995DF, TA-X995DF-8, TA-X997, TA-X997LD, TA-X997DF, TA-X998, TA-X998LD, TA-X998DF, TA-X998DF-8, TA-X1000, TA-X1000LD, TA-X1000DF, TA-X1005, TA-X1005LD, TA-X1005DF, TA-X1005DF-8, TA-X1007, TA-X1007LD, TA-X1007DF, TA-X1008, TA-X1008LD, TA-X1008DF, TA-X1008DF-8, TA-X1010, TA-X1010LD, TA-X1010DF, TA-X1015, TA-X1015LD, TA-X1015DF, TA-X1015DF-8, TA-X1017, TA-X1017LD, TA-X1017DF, TA-X1018, TA-X1018LD, TA-X1018DF, TA-X1018DF-8, TA-X1020, TA-X1020LD, TA-X1020DF, TA-X1025, TA-X1025LD, TA-X1025DF, TA-X1025DF-8, TA-X1027, TA-X1027LD, TA-X1027DF, TA-X1028, TA-X1028LD, TA-X1028DF, TA-X1028DF-8, TA-X1030, TA-X1030LD, TA-X1030DF, TA-X1035, TA-X1035LD, TA-X1035DF, TA-X1035DF-8, TA-X1037, TA-X1037LD, TA-X1037DF, TA-X1038, TA-X1038LD, TA-X1038DF, TA-X1038DF-8, TA-X1040, TA-X1040LD, TA-X1040DF, TA-X1045, TA-X1045LD, TA-X1045DF, TA-X1045DF-8, TA-X1047, TA-X1047LD, TA-X1047DF, TA-X1048, TA-X1048LD, TA-X1048DF, TA-X1048DF-8, TA-X1050, TA-X1050LD, TA-X1050DF, TA-X1055, TA-X1055LD, TA-X1055DF, TA-X1055DF-8, TA-X1057, TA-X1057LD, TA-X1057DF, TA-X1058, TA-X1058LD, TA-X1058DF, TA-X1058DF-8, TA-X1060, TA-X1060LD, TA-X1060DF, TA-X1065, TA-X1065LD, TA-X1065DF, TA-X1065DF-8, TA-X1067, TA-X1067LD, TA-X1067DF, TA-X1068, TA-X1068LD, TA-X1068DF, TA-X1068DF-8, TA-X1070, TA-X1070LD, TA-X1070DF, TA-X1075, TA-X1075LD, TA-X1075DF, TA-X1075DF-8, TA-X1077, TA-X1077LD, TA-X1077DF, TA-X1078, TA-X1078LD, TA-X1078DF, TA-X1078DF-8, TA-X1080, TA-X1080LD, TA-X1080DF, TA-X1085, TA-X1085LD, TA-X1085DF, TA-X1085DF-8, TA-X1087, TA-X1087LD, TA-X1087DF, TA-X1088, TA-X1088LD, TA-X1088DF, TA-X1088DF-8, TA-X1090, TA-X1090LD, TA-X1090DF, TA-X1095, TA-X1095LD, TA-X1095DF, TA-X1095DF-8, TA-X1097, TA-X1097LD, TA-X1097DF, TA-X1098, TA-X1098LD, TA-X1098DF, TA-X1098DF-8, TA-X1100, TA-X1100LD, TA-X1100DF, TA-X1105, TA-X1105LD, TA-X1105DF, TA-X1105DF-8, TA-X1107, TA-X1107LD, TA-X1107DF, TA-X1108, TA-X1108LD, TA-X1108DF, TA-X1108DF-8, TA-X1110, TA-X1110LD, TA-X1110DF, TA-X1115, TA-X1115LD, TA-X1115DF, TA-X1115DF-8, TA-X1117, TA-X1117LD, TA-X1117DF, TA-X1118, TA-X1118LD, TA-X1118DF, TA-X1118DF-8, TA-X1120, TA-X1120LD, TA-X1120DF, TA-X1125, TA-X1125LD, TA-X1125DF, TA-X1125DF-8, TA-X1127, TA-X1127LD, TA-X1127DF, TA-X1128, TA-X1128LD, TA-X1128DF, TA-X1128DF-8, TA-X1130, TA-X1130LD, TA-X1130DF, TA-X1135, TA-X1135LD, TA-X1135DF, TA-X1135DF-8, TA-X1137, TA-X1137LD, TA-X1137DF, TA-X1138, TA-X1138LD, TA-X1138DF, TA-X1138DF-8, TA-X1140, TA-X1140LD, TA-X1140DF, TA-X1145, TA-X1145LD, TA-X1145DF, TA-X1145DF-8, TA-X1147, TA-X1147LD, TA-X1147DF, TA-X1148, TA-X1148LD, TA-X1148DF, TA-X1148DF-8, TA-X1150, TA-X1150LD, TA-X1150DF, TA-X1155, TA-X1155LD, TA-X1155DF, TA-X1155DF-8, TA-X1157, TA-X1157LD, TA-X1157DF, TA-X1158, TA-X1158LD, TA-X1158DF, TA-X1158DF-8, TA-X1160, TA-X1160LD, TA-X1160DF, TA-X1165, TA-X1165LD, TA-X1165DF, TA-X1165DF-8, TA-X1167, TA-X1167LD, TA-X1167DF, TA-X1168, TA-X1168LD, TA-X1168DF, TA-X1168DF-8, TA-X1170, TA-X1170LD, TA-X1170DF, TA-X1175, TA-X1175LD, TA-X1175DF, TA-X1175DF-8, TA-X1177, TA-X1177LD, TA-X1177DF, TA-X1178, TA-X1178LD, TA-X1178DF, TA-X1178DF-8, TA-X1180, TA-X1180LD, TA-X1180DF, TA-X1185, TA-X1185LD, TA-X1185DF, TA-X1185DF-8, TA-X1187, TA-X1187LD, TA-X1187DF, TA-X1188, TA-X1188LD, TA-X1188DF, TA-X1188DF-8, TA-X1190, TA-X1190LD, TA-X1190DF, TA-X1195, TA-X1195LD, TA-X1195DF, TA-X1195DF-8, TA-X1197, TA-X1197LD, TA-X1197DF, TA-X1198, TA-X1198LD, TA-X1198DF, TA-X1198DF-8, TA-X1200, TA-X1200LD, TA-X1200DF, TA-X1205, TA-X1205LD, TA-X1205DF, TA-X1205DF-8, TA-X1207, TA-X1207LD, TA-X1207DF, TA-X1208, TA-X1208LD, TA-X1208DF, TA-X1208DF-8, TA-X1210, TA-X1210LD, TA-X1210DF, TA-X1215, TA-X1215LD, TA-X1215DF, TA-X1215DF-8, TA-X1217, TA-X1217LD, TA-X1217DF, TA-X1218, TA-X1218LD, TA-X1218DF, TA-X1218DF-8, TA-X1220, TA-X1220LD, TA-X1220DF, TA-X1225, TA-X1225LD, TA-X1225DF, TA-X1225DF-8, TA-X1227, TA-X1227LD, TA-X1227DF, TA-X1228, TA-X1228LD, TA-X1228DF, TA-X1228DF-8, TA-X1230, TA-X1230LD, TA-X1230DF, TA-X1235, TA-X1235LD, TA-X1235DF, TA-X1235DF-8, TA-X1237, TA-X1237LD, TA-X1237DF, TA-X1238, TA-X1238LD, TA-X1238DF, TA-X1238DF-8, TA-X1240, TA-X1240LD, TA-X1240DF, TA-X1245, TA-X1245LD, TA-X1245DF, TA-X1245DF-8, TA-X1247, TA-X1247LD, TA-X1247DF, TA-X1248, TA-X1248LD, TA-X1248DF, TA-X1248DF-8, TA-X1250, TA-X1250LD, TA-X1250DF, TA-X1255, TA-X1255LD, TA-X1255DF, TA-X1255DF-8, TA-X1257, TA-X1257LD, TA-X1257DF, TA-X1258, TA-X1258LD, TA-X1258DF, TA-X1258DF-8, TA-X1260, TA-X1260LD, TA-X1260DF, TA-X1265, TA-X1265LD, TA-X1265DF, TA-X1265DF-8, TA-X1267, TA-X1267LD, TA-X1267DF, TA-X1268, TA-X1268LD, TA-X1268DF, TA-X1268DF-8, TA-X1270, TA-X1270LD, TA-X1270DF, TA-X1275, TA-X1275LD, TA-X1275DF, TA-X1275DF-8, TA-X1277, TA-X1277LD, TA-X1277DF, TA-X1278, TA-X1278LD, TA-X1278DF, TA-X1278DF-8, TA-X1280, TA-X1280LD, TA-X1280DF, TA-X1285, TA-X1285LD, TA-X1285DF, TA-X1285DF-8, TA-X1287, TA-X1287LD, TA-X1287DF, TA-X1288, TA-X1288LD, TA-X1288DF, TA-X1288DF-8, TA-X1290, TA-X1290LD, TA-X1290DF, TA-X1295, TA-X1295LD, TA-X1295DF, TA-X1295DF-8, TA-X1297, TA-X1297LD, TA-X1297DF, TA-X1298, TA-X1298LD, TA-X1298DF, TA-X1298DF-8, TA-X1300, TA-X1300LD, TA-X1300DF, TA-X1305, TA-X1305LD, TA-X1305DF, TA-X1305DF-8, TA-X1307, TA-X1307LD, TA-X1307DF, TA-X1308, TA-X1308LD, TA-X1308DF, TA-X1308DF-8, TA-X1310, TA-X1310LD, TA-X1310DF, TA-X1315, TA-X1315LD, TA-X1315DF, TA-X1315DF-8, TA-X1317, TA-X1317LD, TA-X1317DF, TA-X1318, TA-X1318LD, TA-X1318DF, TA-X1318DF-8, TA-X1320, TA-X1320LD, TA-X1320DF, TA-X1325, TA-X1325LD, TA-X1325DF, TA-X1325DF-8, TA-X1327, TA-X1327LD, TA-X1327DF, TA-X1328, TA-X1328LD, TA-X1328DF, TA-X1328DF-8, TA-X1330, TA-X1330LD, TA-X1330DF, TA-X1335, TA-X1335LD, TA-X1335DF, TA-X1335DF-8, TA-X1337, TA-X1337LD, TA-X1337DF, TA-X1338, TA-X1338LD, TA-X1338DF, TA-X1338DF-8, TA-X1340, TA-X1340LD, TA-X1340DF, TA-X1345, TA-X1345LD, TA-X1345DF, TA-X1345DF-8, TA-X1347, TA-X1347LD, TA-X1347DF, TA-X1348, TA-X1348LD, TA-X1348DF, TA-X1348DF-8, TA-X1350, TA-X1350LD, TA-X1350DF, TA-X1355, TA-X1355LD, TA-X1355DF, TA-X1355DF-8, TA-X1357, TA-X1357LD, TA-X1357DF, TA-X1358, TA-X1358LD, TA-X1358DF, TA-X1358DF-8, TA-X1360, TA-X1360LD, TA-X1360DF, TA-X1365, TA-X1365LD, TA-X1365DF, TA-X1365DF-8, TA-X1367, TA-X1367LD, TA-X1367DF, TA-X1368, TA-X1368LD, TA-X1368DF, TA-X1368DF-8, TA-X1370, TA-X1370LD, TA-X1370DF, TA-X1375, TA-X1375LD, TA-X1375DF, TA-X1375DF-8, TA-X1377, TA-X1377LD, TA-X1377DF, TA-X1378, TA-X1378LD, TA-X1378DF, TA-X1378DF-8, TA-X1380, TA-X1380LD, TA-X1380DF, TA-X1385, TA-X1385LD, TA-X1385DF, TA-X1385DF-8, TA-X1387, TA-X1387LD, TA-X1387DF, TA-X1388, TA-X1388LD, TA-X1388DF, TA-X1388DF-8, TA-X1390, TA-X1390LD, TA-X1390DF, TA-X1395, TA-X1395LD, TA-X1395DF, TA-X1395DF-8, TA-X1397, TA-X1397LD, TA-X1397DF, TA-X1398, TA-X1398LD, TA-X1398DF, TA-X1398DF-8, TA-X1400, TA-X1400LD, TA-X1400DF, TA-X1405, TA-X1405LD, TA-X1405DF, TA-X1405DF-8, TA-X1407, TA-X1407LD, TA-X1407DF, TA-X1408, TA-X1408LD, TA-X1408DF, TA-X1408DF-8, TA-X1410, TA-X1410LD, TA-X1410DF, TA-X1415, TA-X1415LD, TA-X1415DF, TA-X1415DF-8, TA-X1417, TA-X1417LD, TA-X1417DF, TA-X1418, TA-X1418LD, TA-X1418DF, TA-X1418DF-8, TA-X1420, TA-X1420LD, TA-X1420DF, TA-X1425, TA-X1425LD, TA-X1425DF, TA-X1425DF-8, TA-X1427, TA-X1427LD, TA-X1427DF, TA-X1428, TA-X1428LD, TA-X1428DF, TA-X1428DF-8, TA-X1430, TA-X1430LD, TA-X1430DF, TA-X1435, TA-X1435LD, TA-X1435DF, TA-X1435DF-8, TA-X1437, TA-X1437LD, TA-X1437DF, TA-X1438, TA-X1438LD, TA-X1438DF, TA-X1438DF-8, TA-X1440, TA-X1440LD, TA-X1440DF, TA-X1445, TA-X1445LD, TA-X1445DF, TA-X1445DF-8, TA-X1447, TA-X1447LD, TA-X1447DF, TA-X1448, TA-X1448LD, TA-X1448DF, TA-X1448DF-8, TA-X1450, TA-X1450LD, TA-X1450DF, TA-X1455, TA-X1455LD, TA-X1455DF, TA-X1455DF-8, TA-X1457, TA-X1457LD, TA-X1457DF, TA-X1458, TA-X1458LD, TA-X1458DF, TA-X1458DF-8, TA-X1460, TA-X1460LD, TA-X1460DF, TA-X1465, TA-X1465LD, TA-X1465DF, TA-X1465DF-8, TA-X1467, TA-X1467LD, TA-X1467DF, TA-X1468, TA-X1468LD, TA-X1468DF, TA-X1468DF-8, TA-X1470, TA-X1470LD, TA-X1470DF, TA-X1475, TA-X1475LD, TA-X1475DF, TA-X1475DF-8, TA-X1477, TA-X1477LD, TA-X1477DF, TA-X1478, TA-X1478LD, TA-X1478DF, TA-X1478DF-8, TA-X1480, TA-X1480LD, TA-X1480DF, TA-X1485, TA-X1485LD, TA-X1485DF, TA-X1485DF-8, TA-X1487, TA-X1487LD, TA-X1487DF, TA-X1488, TA-X1488LD, TA-X1488DF, TA-X1488DF-8, TA-X1490, TA-X1490LD, TA-X1490DF, TA-X1495, TA-X1495LD, TA-X1495DF, TA-X1495DF-8, TA-X1497, TA-X1497LD, TA-X1497DF, TA-X1498, TA-X1498LD, TA-X1498DF, TA-X1498DF-8, TA-X1500, TA-X1500LD, TA-X1500DF, TA-X1505, TA-X1505LD, TA-X1505DF, TA-X1505DF-8, TA-X1507, TA-X1507LD, TA-X1507DF, TA-X1508, TA-X1508LD, TA-X1508DF, TA-X1508DF-8, TA-X1510, TA-X1510LD, TA-X1510DF, TA-X1515, TA-X1515LD, TA-X1515DF, TA-X1515DF-8, TA-X1517, TA-X1517LD, TA-X1517DF, TA-X1518, TA-X1518LD, TA-X1518DF, TA-X1518DF-8, TA-X1520, TA-X1520LD, TA-X1520DF, TA-X1525, TA-X1525LD, TA-X1525DF, TA-X1525DF-8, TA-X1527, TA-X1527LD, TA-X1527DF, TA-X1528, TA-X1528LD, TA-X1528DF, TA-X1528DF-8, TA-X1530, TA-X1530LD, TA-X1530DF, TA-X1535, TA-X1535LD, TA-X1535DF, TA-X1535DF-8, TA-X1537, TA-X1537LD, TA-X1537DF, TA-X1538, TA-X1538LD, TA-X1538DF, TA-X1538DF-8, TA-X1540, TA-X1540LD, TA-X1540DF, TA-X1545, TA-X1545LD, TA-X1545DF, TA-X1545DF-8, TA-X1547, TA-X1547LD, TA-X1547DF, TA-X1548, TA-X1548LD, TA-X1548DF, TA-X1548DF-8, TA-X1550, TA-X1550LD, TA-X1550DF, TA-X1555, TA-X1555LD, TA-X1555DF, TA-X1555DF-8, TA-X1557, TA-X1557LD, TA-X1557DF, TA-X1558, TA-X1558LD, TA-X1558DF, TA-X1558DF-8, TA-X1560, TA-X1560LD, TA-X1560DF, TA-X1565, TA-X1565LD, TA-X1565DF, TA-X1565DF-8, TA-X1567, TA-X1567LD, TA-X1567DF, TA-X1568, TA-X1568LD, TA-X1568DF, TA-X1568DF-8, TA-X1570, TA-X1570LD, TA-X1570DF, TA-X1575, TA-X1575LD, TA-X1575DF, TA-X1575DF-8, TA-X1577, TA-X1577LD, TA-X1577DF, TA-X1578, TA-X1578LD, TA-X1578DF, TA-X1578DF-8, TA-X1580, TA-X1580LD, TA-X1580DF, TA-X1585, TA-X1585LD, TA-X1585DF, TA-X1585DF-8, TA-X1587, TA-X1587LD, TA-X1587DF, TA-X1588, TA-X1588LD, TA-X1588DF, TA-X1588DF-8, TA-X1590, TA-X1590LD, TA-X1590DF, TA-X1595, TA-X1595LD, TA-X1595DF, TA-X1595DF-8, TA-X1597, TA-X1597LD, TA-X1597DF, TA-X1598, TA-X1598LD, TA-X1598DF, TA-X1598DF-8, TA-X1600, TA-X1600LD, TA-X1600DF, TA-X1605, TA-X1605LD, TA-X1605DF, TA-X1605DF-8, TA-X1607, TA-X1607LD, TA-X1607DF, TA-X1608, TA-X1608LD, TA-X1608DF, TA-X1608DF-8, TA-X1610, TA-X1610LD, TA-X1610DF, TA-X1615, TA-X1615LD, TA-X1615DF, TA-X1615DF-8, TA-X1617, TA-X1617LD, TA-X1617DF, TA-X1618, TA-X1618LD, TA-X1618DF, TA-X1618DF-8, TA-X1620, TA-X1620LD, TA-X1620DF, TA-X1625, TA-X1625LD, TA-X1625DF, TA-X1625DF-8, TA-X1627, TA-X1627LD, TA-X1627DF, TA-X1628, TA-X1628LD, TA-X1628DF, TA-X1628DF-8, TA-X1630, TA-X1630LD, TA-X1630DF, TA-X1635, TA-X1635LD, TA-X1635DF, TA-X1635DF-8, TA-X1637, TA-X1637LD, TA-X1637DF, TA-X1638, TA-X1638LD



Product Display

02

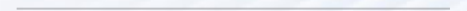



Model:6622

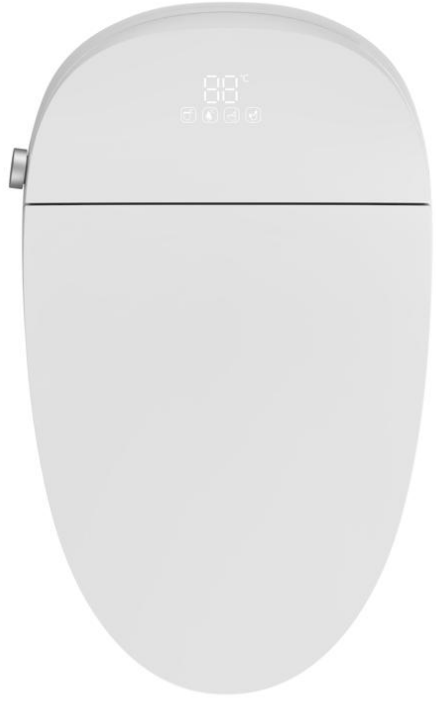

Drawing(ADA)

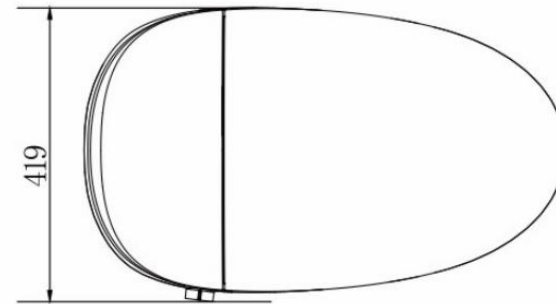
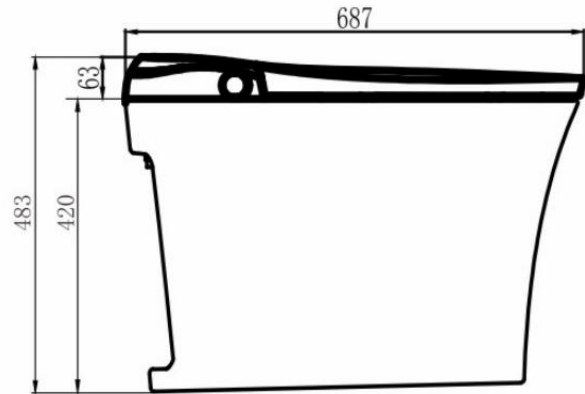



Technology

03

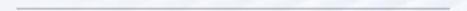

Soft oxygen kinetic energy technology



ABS Nozzle



316 stainless nozzle body



316 stainless nozzle body+ABS nozzle



Using the Venturi principle, air is naturally inhaled during the cleaning process, allowing air and water to combine, making the cleaning water column softer and more comfortable.

Cleaning Mode

ULTRA-SOFT REARWASH

Patented technology supports full mixing of water and oxygen, making cleaning more comfortable



ULTRA-SOFT FRONT WASH

SPA-style gentle bubble water wash, care for women's cleanliness



LIGHT FRONT WASH

Umbrella-shaped water column, water mist for large-scale cleaning, special protection in special periods



RHYTHMIC REARWASH

Stable water pressure, high-frequency pulse water flow, spot-type strong cleaning power



POWER WASH

Strong water flow stimulates the sphincter and promotes defecation

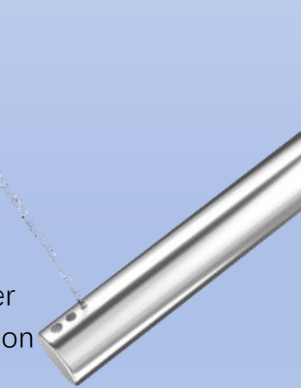

PROMOTING DEFECATE WASH

High water pressure strong flushing, direct to help defecation



X-Power Flushing Technology



Pump drive pressurization and mechanical flush stop. Under the double gathering force, powerful flushing force can be quickly released.



SYNCHRONOUS RAPID FLUSHING TECHNOLOGY



Pump drive pressurization and mechanical flush stop. Under the double gathering force, powerful flushing force can be quickly released.



Self-cleaning glaze technology

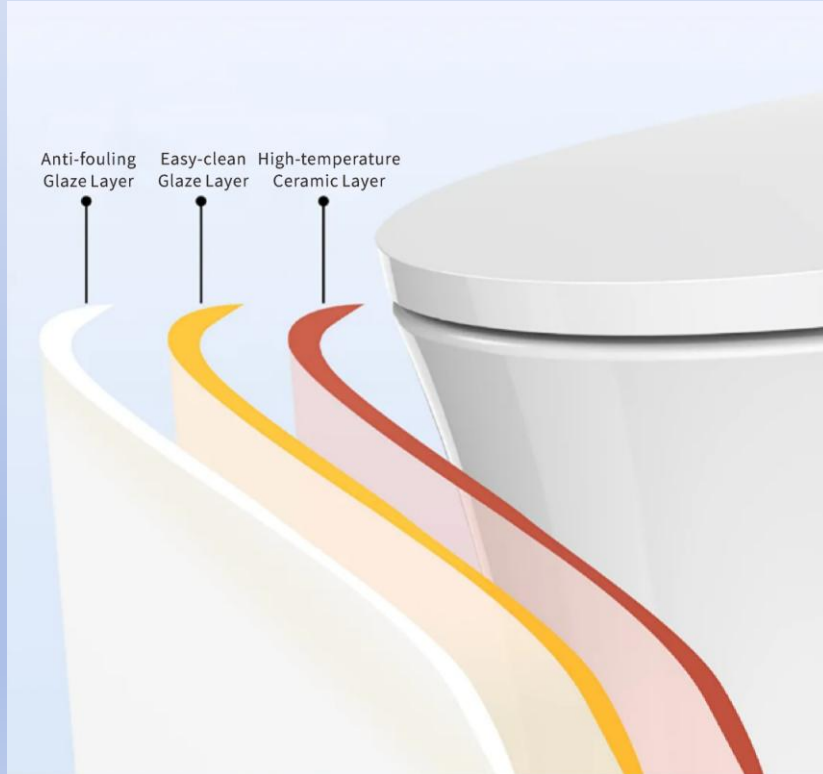

The ceramic is calcined at 1280°C and uses a self-cleaning glaze, which greatly improves the smoothness and glaze density. The water absorption rate is less than 0.3%, and it has good anti-fouling properties, making the toilet smoother and easier to clean.

Ultra-clean bubble shield technology☆



The bubble generator allows the bubble agent, air and water to be organically combined to produce rich and dense bubbles that cover the toilet water seal, thereby playing the role of "antibacterial, anti-fouling, odor-isolating and splash-proof", creating a refreshing toilet experience space.

广微通
Gwide Tong

MA 100% RESIN GWAS

广东省微生物检测中心
GUANGDONG PROVINCE MICROBIOLOGY DETECTION CENTER
广东省微生物检测中心
广东省微生物检测中心

菌株名称	菌株来源	菌株用途	菌株特性	菌株编号
大肠杆菌	ATCC 25922	革兰氏阴性	产酸产气	010101
金黄色葡萄球菌	ATCC 29219	革兰氏阳性	凝固酶阳性	010102
铜绿假单胞菌	ATCC 27956	革兰氏阴性	产酸产气	010103
肺炎克雷伯菌	ATCC 35961	革兰氏阴性	产酸产气	010104
沙门氏菌	ATCC 14028	革兰氏阴性	产酸产气	010105

广微通

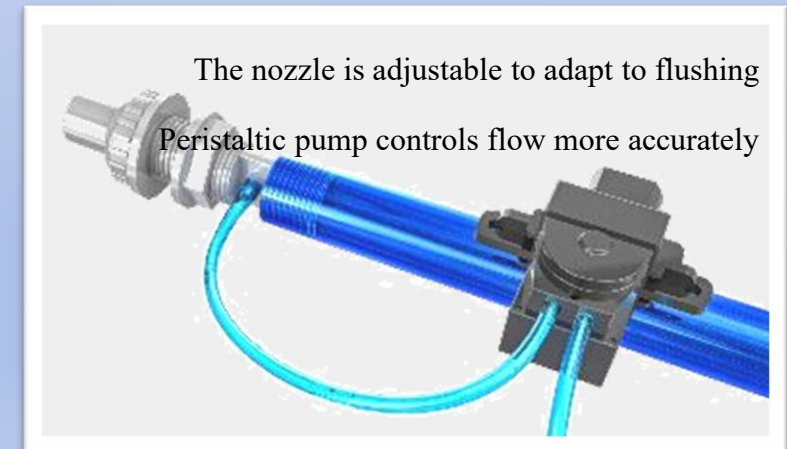

Nozzle UV Sterilization

The nozzle uses UVCband, 275nm wavelength deep ultraviolet physical sterilization, double sterilization before and after water discharge. It starts 15 seconds after leaving the seat, and repeats every 4 hours, which is more efficient.

 检测编号: S22008452 Test No. S22008452 广州市微生物研究所 GUANGZHOU INSTITUTE OF MICROBIOLOGY 检测报告 TEST REPORT			
报告日期: 2024年1月11日 Date Issued: 2024-01-11			
样品名称 Name of Sample	规格号 Spec. No.	样品来源 Name of Provider	日期 Date
检测项目 Applicator	微生物检测用注射器	客户	2024-01-11
生产厂家 Manufacturing Company	—	—	—
生产许可证号 Date and Batch Number	—	—	—
样品数量 Quantity of Sample	1 支	—	—
检测方法 Method of Analysis	菌落计数法(GB 4789.1-2016) 非无菌包装的医疗器械、植入体表面菌落计数法(GB 4789.13-2016)		
检测标准/方法 Reference Standard/Method	(GB 4789.1-2016) 第 5.1.2 条 (GB 4789.13-2016) 第 5.1.2 条		
备注 Remarks	1. 本报告中, 检测不合格, 仅对不合格项负责。 2. 本报告中, 检测合格, 仅对合格项负责。		

 检测编号: S22008452 Test No. S22008452 广州市微生物研究所 GUANGZHOU INSTITUTE OF MICROBIOLOGY 检测报告 TEST REPORT			
报告日期: 2024年1月11日 Date Issued: 2024-01-11			
检测项目 Applicator	规格号 Spec. No.	样品来源 Name of Provider	日期 Date
检测项目 Applicator	微生物检测用注射器	客户	2024-01-11
生产厂家 Manufacturing Company	—	—	—
生产许可证号 Date and Batch Number	—	—	—
样品数量 Quantity of Sample	1 支	—	—
检测方法 Method of Analysis	菌落计数法(GB 4789.1-2016) 非无菌包装的医疗器械、植入体表面菌落计数法(GB 4789.13-2016)		
检测标准/方法 Reference Standard/Method	(GB 4789.1-2016) 第 5.1.2 条 (GB 4789.13-2016) 第 5.1.2 条		
备注 Remarks	1. 本报告中, 检测不合格, 仅对不合格项负责。 2. 本报告中, 检测合格, 仅对合格项负责。		



Large air volume drying

Equipped with a high-speed brushless motor, it blows out a large amount of air at a close distance, with a wind speed of about 15 meters per second, far exceeding the national standard of 4 meters per second, improving the drying efficiency.

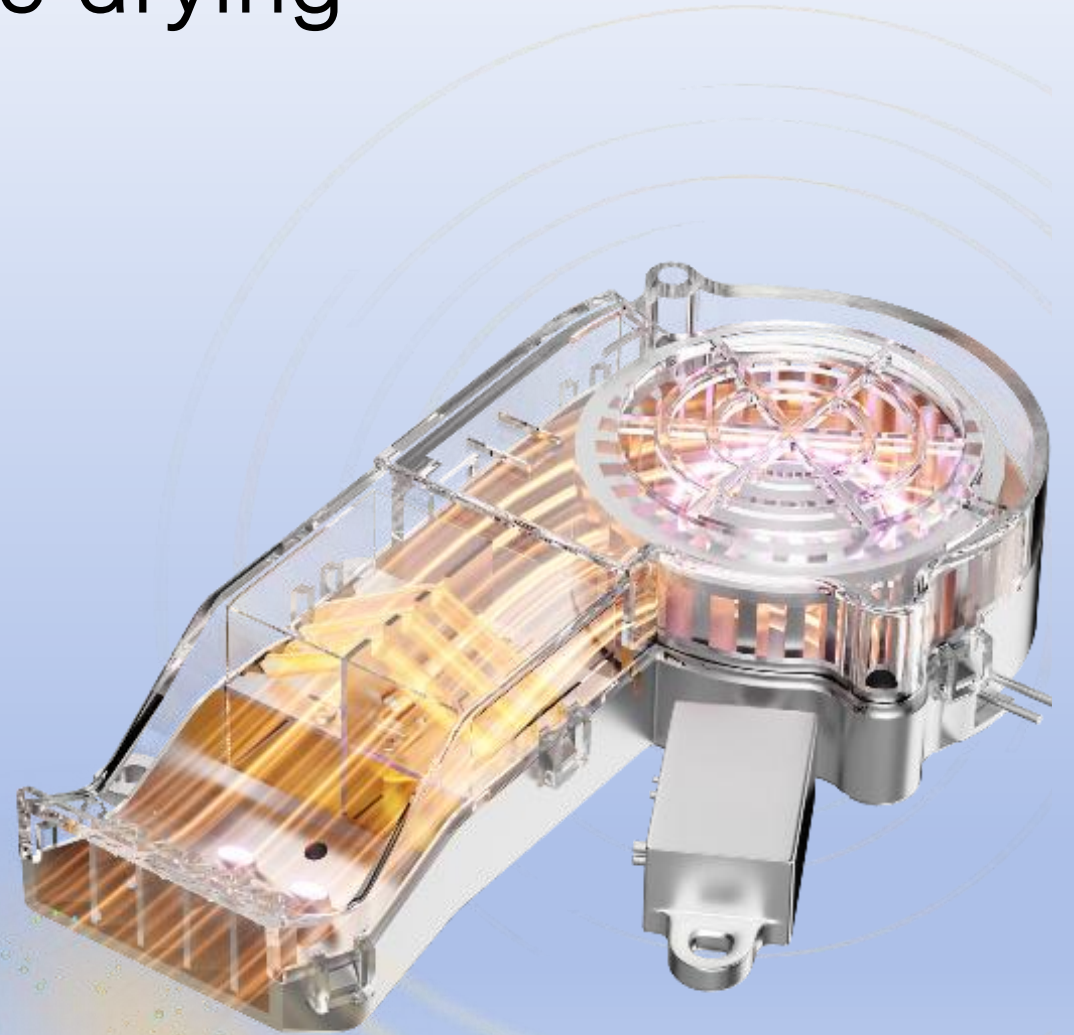

SIAA Antibacterial Seat Ring

SIAA certified antibacterial seat, ergonomic, fast heating and evenly distributed heating points.

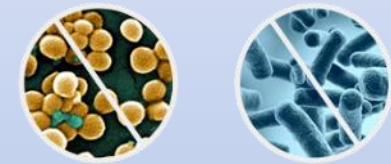
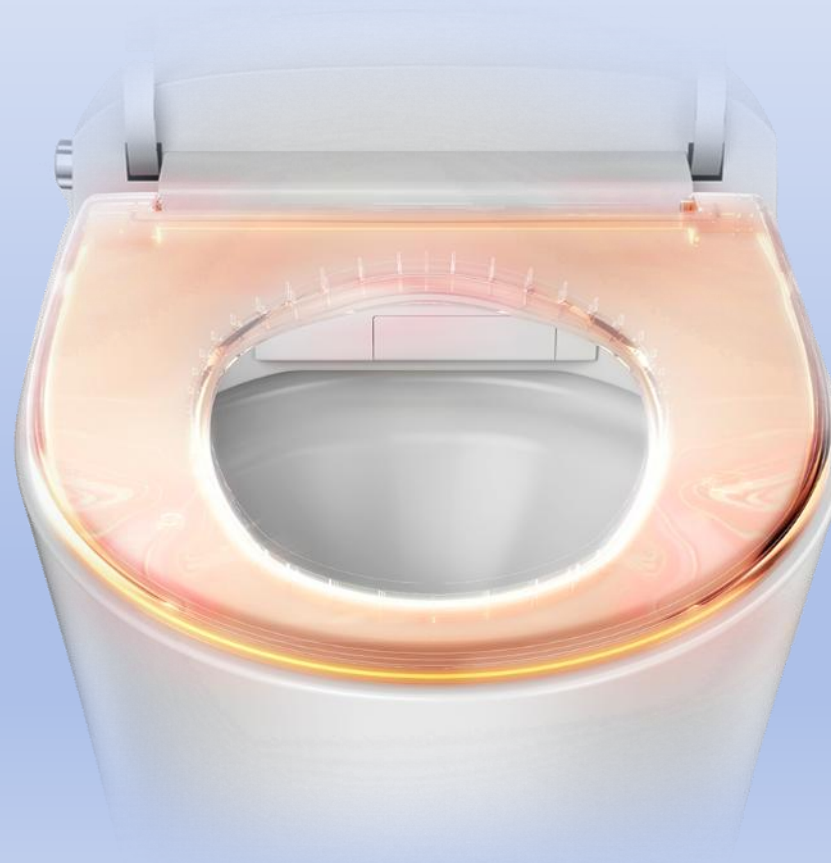

Average distribution of 30 heating points on the seat ring

Automatic Flip

The lid automatically opens when you get close to the front of the toilet and automatically closes two minutes after you leave. New butler mode and adjustment mode have been added.

Butler Mode

Anti-accidental touch: The automatic open function will be turned off within three minutes after the cover is closed manually.

Gesture Operation

The seat cover opens normally, and the seat ring can open it by waving hand in front of the seat ring.

Adjustment Mode

The sensing distance (20-100CM) and the speed of flipping the cover and turning the circle can be adjusted.

Urine Identification

If it senses the falling motion of liquid for more than 5 seconds within a range of 25 cm above the toilet ceramic, it will trigger an automatic flush when you leave.





Foot sensor Technology

You can open the seat cover and seat ring by stretching your foot. According to men's toilet habits, you can use your foot to slide across the bottom sensor switch to realize the flushing function.

Intelligent temperature control technology

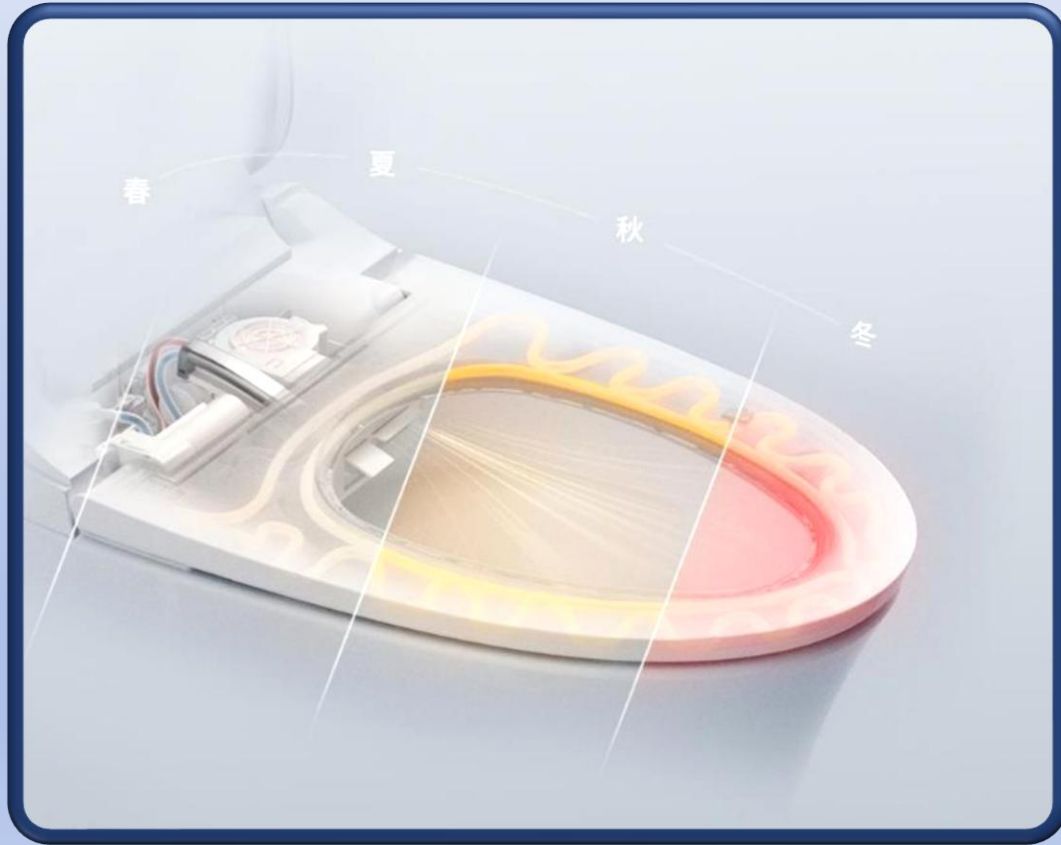

It can intelligently sense the surrounding ambient temperature and automatically adjust the seat temperature and cleaning water temperature according to the ambient temperature. It is like spring all year round, saving energy and electricity and worry-free.

Ambient Temperature	Water Temperature	Seat Temperature	Wind Temperature
<15°C	39°C	39°C	4th Level
15°C-25°C	36°C	33°C	3rd Level
25°C-30°C	33°C	Off	2nd Level
>30°C	33°C	Off	1st Level

Induction Light Night

Intelligently senses the brightness of the environment, automatically turns on the light-sensing night light in a dark environment, and no longer needs to grope in the dark when getting up at night. It automatically turns off when the environment is bright, which is convenient and energy-saving.

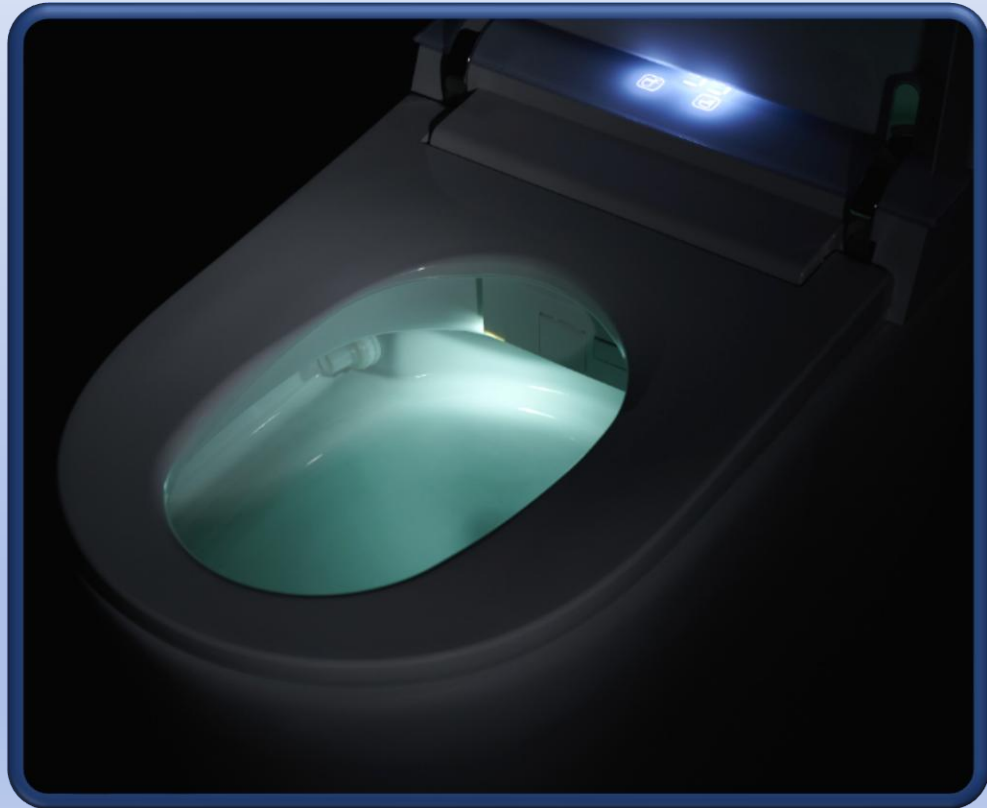



Features & Functions

04

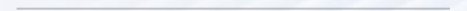

Model	TA-X560DF
remote control	
Cistern/water tank(+ 20USD)	inside water tank
Size(W*L*H mm)	688*418*484mm
Carton size(W*L*H mm)	815*525*635mm
Net/Gross weight(kg)	45/38
Rated power	120V ,1200W,60Hz
Water pressure range	/
Cleansing rate	400-600ml/min
Nozzle material	316 stainless steel nozzle
Heating methord	Instant heat
Angle valve	NPT supply stop and with 3/8 adopter and 1/2 adapter

container loading 40HQ	232pcs
Rear wash	●
Front wash	●
Constant temp washing	●
One solution	●
Massage washing	●
Water pressure adjustment (4 levels)	●
Water temp adjust(4 levels · normal-33-36-39°C)	●
Nozzle position adjust, 5 levels	●
Soft wash(water and air mixed) with patent	●
Antibiosis nozzle	●
Auto wash nozzle	●
Heated seat(4 levels · normal-33-36-39°C)	●
Dryer temp adjust((4 levels · 40°-52°C))	●
Auto deodorizer	●

Rotate knob control	●
Breathe light	●
Soft close	●
LED Display	●
Tuya app	★
Night light	●
Seat sensor	●
Human Sensor (Radar)	●
Foot sensor (flush)	●
Foot sensor (open)	●
Toilet cover/seat auto open/close	●
Remote open/close toilet cover and seat	●
Remote flush	●
Easy click flush button	●
Auto flush	●

Packaging method

Carton

8pcs toilet/ Pallet 32pcs smart toilet seats/Pallet

Wooden box (Extra \$50)



FPB NINGBO

20-foot container/40-foot container

102pcs/278pcs



Flange bolts



Screw



Remote control



Steel washers



Flange



Nuts



Angle valve



Steel washers



Expansion bolts



Remote control battery



1/2 & 9/16



Decorative cover



Battery Box



Flange screws



Expansion screws





THANK YOU
